



Empresa 100% Nacional



Miaqenge®



CATÁLOGO DE PRODUTOS 2023





A Miaqenge é uma empresa especializada na fabricação e comercialização de peças e componentes da linha a gás para equipamentos de gastronomia tanto para linha industrial como doméstica. Atuamos também no ramo da construção civil com produtos destinados a canalização de redes de gás bem como flexíveis para água quente e fria.

Estamos instalados em uma área construída de 5.000 m² com máquinas e equipamentos de tecnologia avançada que nos possibilitam produzir com qualidade e rapidez uma linha completa de produtos destinados a fabricação de equipamentos para gastronomia como: fogões e fornos industriais, churrasqueiras, assadores, etc.

Contamos com um quadro de 70 colaboradores treinados e preparados para atender adequadamente as demandas mais exigentes do mercado.

Produzimos mais de 1500 itens que contemplam toda a demanda do segmento a gás. Desenvolvemos e produzimos, também, produtos especiais para clientes de pequeno, médio e grande porte que atendam às necessidades específicas de cada um.

A obtenção da certificação ISO 9001 – 2015 e os mais de 20 anos de fundação da Miaqenge, consolidam nossa posição de destaque na produção e comercialização de produtos de qualidade e de atendimento no padrão adequado, de acordo com as necessidades dos clientes.

Qualidade, inovação, agilidade, atendimento e preços competitivos são diferenciais que nos caracterizam, por isso, buscamos ser cada vez mais parceiros para conquistar nossos objetivos comuns.

	Queimadores	04
	Ligações Flexíveis	10
	Mangueiras Nitrílicas	13
	Conjuntos de Instalação	18
	Flexíveis com Borracha Nitrílica	19
	Flexível Inox	20
	Flexível Anti-Ruído	21
	Ligações Flexíveis com Registro	22
	Coletor de Gás	23
	Registros	24
	Nipples e Conexões	28
	Conexões e Terminais de Latão	31
	Injetores de Latão	34
	Terminais de Alumínio	37
	Engrenagens, Sem Fins e Mancais	39
	Espetos Assadores	41
	Ligações e Maçaneta	42
	Linha PT-300	43

**Queimador Infravermelho 2250 kcal Esmaltado
GLP 190 g/h 8900 BTU/h**

Miaqenge®



Obs.: É necessário regulador de gás Baixa Pressão 2,8 kPa (0,406 PSI)



*Embalagem Individual

GLP/GN

CÓD.	PRODUTO	CÓD. BAR.	PESO (Kg)
502	Queimador com Placa Cerâmica Caixa com 20 unidades	7898586670730	0,924



GLP/GN

CÓD.	PRODUTO	PESO (Kg)
9836	Queimador com Placa Cerâmica Embalagem Coletiva c/ 24 unidades	0,859

DIMENSÕES DOS QUEIMADORES

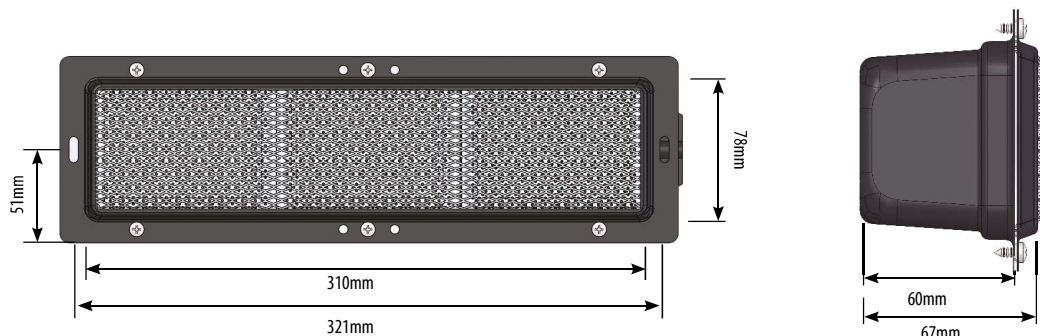

Obs.: É necessário regulador de gás Baixa Pressão 2,8 kPa (0,406 PSI)

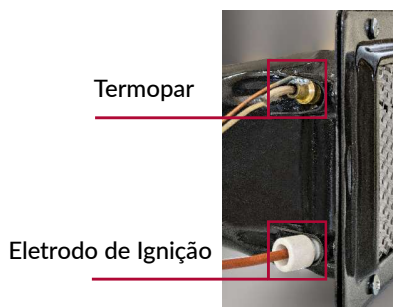

*Não acompanha acessórios, imagem meramente ilustrativa.

GLP/GN

CÓD.	PRODUTO	PESO (Kg)
830	Queimador com Espera para Acendimento Automático e Corta-Chama com Placa Cerâmica Emb. Coletiva c/ 24 un.	0,911



*Não acompanha acessórios, imagem meramente ilustrativa.

GLP/GN

CÓD.	PRODUTO	PESO (Kg)
7300	Queimador com Espera para Acendimento Automático com Placa Cerâmica Embalagem Coletiva com 24 unidades	0,885



CÓD.	PRODUTO	PESO (Kg)
8334	Queimador com Placa Cerâmica (única) Embalagem Coletiva com 24 unidades	0,909

Queimador Infravermelho 1200 kcal a Gás

Maqenge®



Obs.: É necessário regulador de gás Baixa Pressão 2,8 kPa (0,406 PSI)

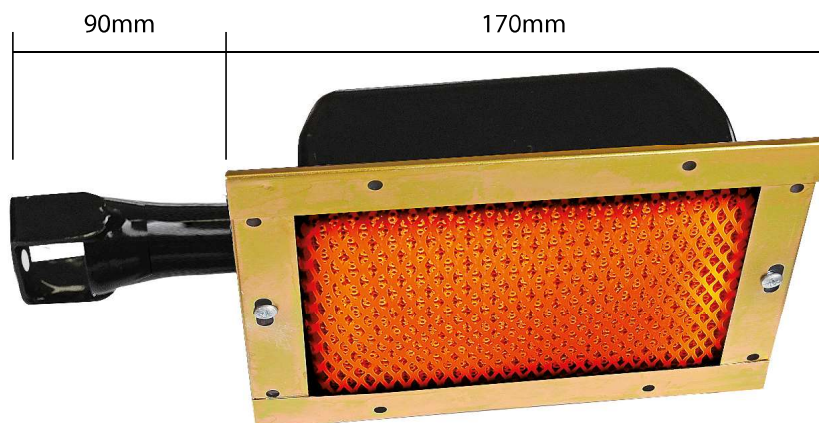

GLP/GN

CÓD.	PRODUTO	CÓD. BAR.	PESO (Kg)
994	Queimador Infravermelho 1200 kcal Esmaltado 110g/h 4700 BTU/h - Embalagem Individual	7908212308934	0,664

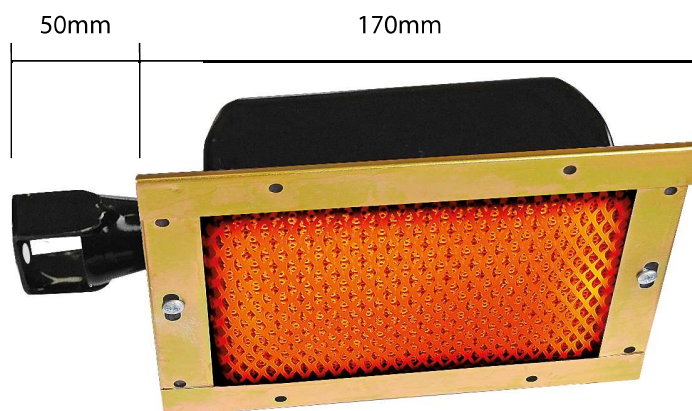

GLP/GN

CÓD.	PRODUTO	CÓD. BAR.	PESO (Kg)
995	Queimador Infravermelho 1200 kcal Esmaltado 110 g/h 4700 BTU/h - Embalagem Individual	7908212308941	0,620

Corpo produzido com chapa de aço carbono laminado a frio, com cobertura de esmalte a fogo, com placas de cerâmica refratária e tela de aço inox AISI 304 expandida.

Pressão de trabalho: 2,8 kPa (0,406 PSI)

Consumo médio de GLP: 110 g/h

Injetor de gás: 0,75mm

Oxigênio de uso: atmosférico

Deve ser usado com regulador de gás.

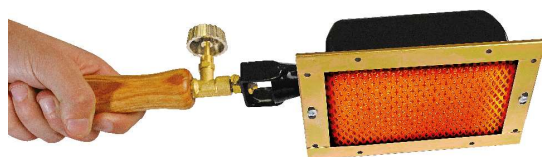

GLP/GN

CÓD.	PRODUTO	CÓD. BAR.	PESO (Kg)
996	Pururucador Infravermelho a Gás Baixa Pressão 2,8 kPa (0,406 PSI) 1200 kcal Esmaltado GLP 110 g/h 4700 BTU/h - Embalagem Individual	7908212308958	1,110

Corpo produzido com chapa de aço carbono laminado a frio, com cobertura de esmalte a fogo, com placas de cerâmica refratária e tela de aço inox AISI 304 expandida.

Pressão de trabalho: 2,8 kPa (0,406 PSI)

Consumo médio de GLP: 110 g/h

Injetor de gás: 0,75mm

Oxigênio de uso: atmosférico

Deve ser usado com regulador de gás.

Queimador Infravermelho 5500 kcal a Gás

Maqenge®



Obs.: É necessário regulador de gás Baixa Pressão 2,8 kPa (0,406 PSI)

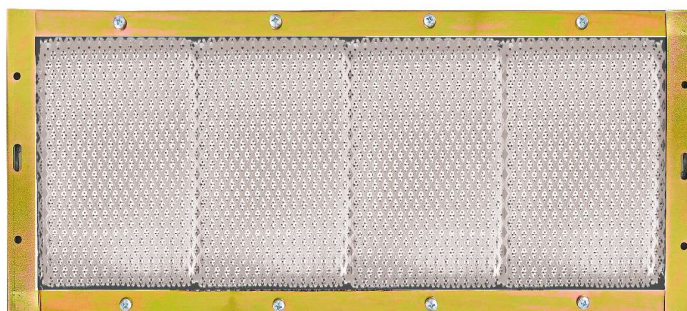
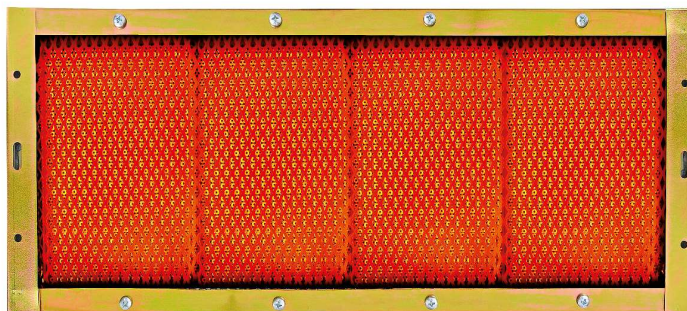

CÓD.	PRODUTO	CÓD. BAR.	PESO (Kg)
993	Queimador Infravermelho 5500 kcal Esmaltado GLP 500 g/h 21800 BTU/h - Embalagem Individual	7908212308927	1,588

Corpo produzido com chapa de aço carbono laminado a frio, com cobertura de esmalte a fogo, com placas de cerâmica refratária e tela de aço inox AISI 304 expandida.

Pressão de trabalho: 2,8 kPa (0,406 PSI)

Consumo médio de GLP: 500 g/h

Injetor de gás: 1,35mm

Oxigênio de uso: atmosférico

Deve ser usado com regulador de gás.



CÓD.	PRODUTO	CÓD. BAR.	PESO (Kg)
10002	Conj. Moldura Esmaltada para Queimador Infravermelho 2250 kcal (10 un.)	7898586671515	0,914



CÓD.	PRODUTO	PESO (Kg)
1000	Moldura para Queimador Infravermelho 5500 kcal	0,102

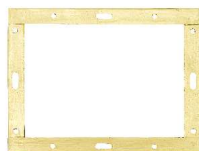

CÓD.	PRODUTO	PESO (Kg)
1003	Moldura para Queimador Infravermelho 1200 kcal	0,052



CÓD.	PRODUTO	CÓD. BAR.	PESO (Kg)
3709	Conj. Tela Inox para Queimador Infravermelho 2250 kcal (10 un.)	7898586670655	0,430

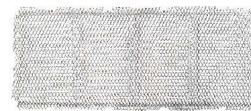

CÓD.	PRODUTO	PESO (Kg)
1016	Tela Inox para Queimador Infravermelho 5500 kcal	0,107

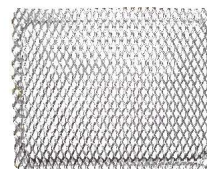

CÓD.	PRODUTO	PESO (Kg)
1017	Tela Inox para Queimador Infravermelho 1200 kcal	0,035



*Embalagem com 40 unidades

CÓD.	PRODUTO	PESO (Kg)
786	Placa Cerâmica para Queimador Infravermelho 2250 kcal - 150 x 70 x 13 mm	0,213



*Embalagem com 20 unidades

CÓD.	PRODUTO	PESO (Kg)
20127	Placa Cerâmica para Queimador Infravermelho 1200 kcal e 5500 kcal - 132 x 92 x 13 mm	0,133



CÓD.	PRODUTO	PESO (Kg)
2512	Presilha para Queimador Infravermelho 2250 kcal	0,002



CÓD.	PRODUTO	PESO (Kg)
107	Parafuso Phillips para Queimador Infravermelho	0,001



CÓD.	PRODUTO	PESO (Kg)
983	Fita Adesiva 13 x 460mm para Queimador Infravermelho 1200 kcal	0,006
2710	Fita Adesiva 13 x 746mm para Queimador Infravermelho 2250 kcal	0,011
984	Fita Adesiva 13 x 1010mm para Queimador Infravermelho 5500 kcal	0,016

Flexíveis Tomback NBR 14177 (Produto Certificado) para GLP/GN

Maqenge[®]



Utilizar em baixa pressão (abaixo de 5kPa) - Temperatura máxima 120°C

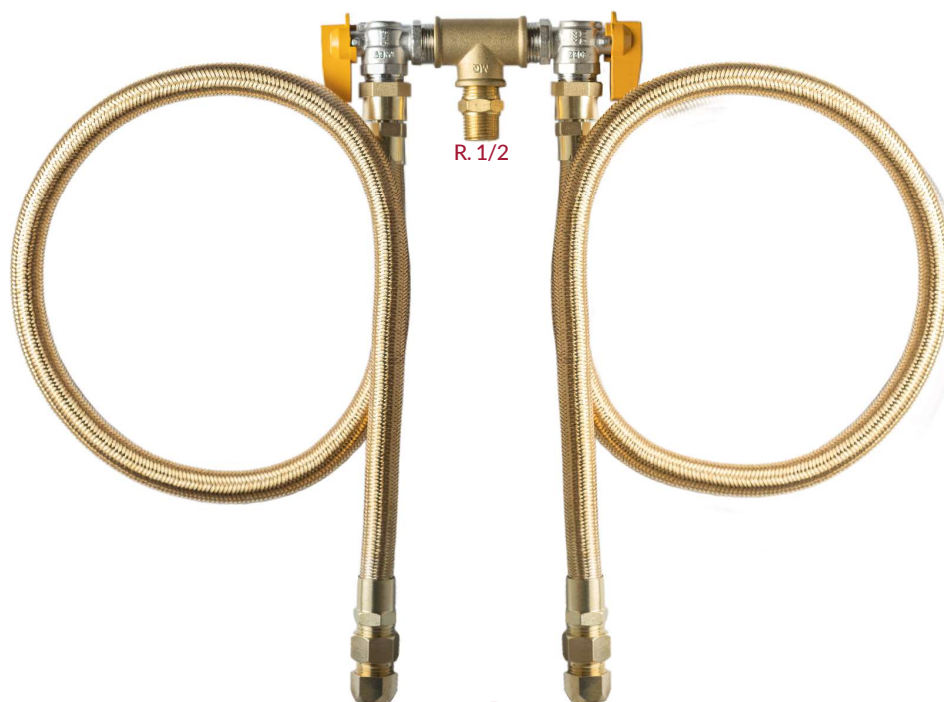

LANÇAMENTO



02x Adaptador Aperto Rápido TM 3/8

CÓD.	PRODUTO	CÓD. BAR.	PESO (Kg)
1908	Kit Para Instalação Gás Fornos, Fogões e Cooktop com Aperto Rápido 1000mm Emb. Ind.	7908212310555	1,280
1909	Kit Para Instalação Gás Fornos, Fogões e Cooktop com Aperto Rápido 1200mm Emb. Ind.	7908212310562	1,390



LANÇAMENTO

CÓD.	PRODUTO	CÓD. BAR.	PESO (Kg)
1790	Flex Tomback GLP/GN 16(l)X400mm R.1/2 NPT(E) X 3/4 BSP(I) Emb. Ind.	7908212310548	0,420

Utilizar em baixa pressão (abaixo de 5kPa) - Temperatura máxima 120°C

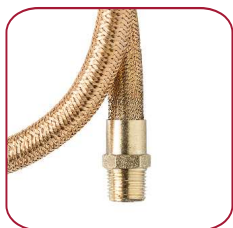

1/2 BSPT(E)



1/2 BSP(I)



EMBALAGEM INDIVIDUAL

BAIXA PRESSÃO

CÓD.	PRODUTO	CÓD. BAR.	PESO (Kg)
10418	Flexível 1/2 (I) x 300mm - R. 1/2 BSPT (E) x 1/2 BSP (I)	7898586671904	0,189
10419	Flexível 1/2 (I) x 400mm - R. 1/2 BSPT (E) x 1/2 BSP (I)	7898586671911	0,215
10420	Flexível 1/2 (I) x 500mm - R. 1/2 BSPT (E) x 1/2 BSP (I)	7898586671928	0,250
10421	Flexível 1/2 (I) x 600mm - R. 1/2 BSPT (E) x 1/2 BSP (I)	7898586671935	0,260
10422	Flexível 1/2 (I) x 800mm - R. 1/2 BSPT (E) x 1/2 BSP (I)	7898586671942	0,335
10395	Flexível 1/2 (I) x 1000mm - R. 1/2 BSPT (E) x 1/2 BSP (I)	7898586671959	0,353
10423	Flexível 1/2 (I) x 1200mm - R. 1/2 BSPT (E) x 1/2 BSP (I)	7898586671966	0,426

Ligações Flexíveis Tomback para Instalação de Gás GLP/GN

Utilizar em baixa pressão (abaixo de 5kPa) - Temperatura Máxima 120°C

CÓD.	PRODUTO	CÓD. BAR.	PESO (Kg)
891	Flexível 1/2 (I) x 1500mm - R. 1/2 BSPT (E) x 1/2 BSP (I)	7908212308538	0,513
892	Flexível 1/2 (I) x 2000mm - R. 1/2 BSPT (E) x 1/2 BSP (I)	7908212308545	0,627
938	Flexível 1/2 (I) x 2500mm - R. 1/2 BSPT (E) x 1/2 BSP (I)	7908212308699	0,781
893	Flexível 1/2 (I) x 3000mm - R. 1/2 BSPT (E) x 1/2 BSP (I)	7908212308552	0,772

Flexíveis Tomback NBR 14177 (Produto Certificado) para GLP/GN

Maqenge[®]



Utilizar em baixa pressão (abaixo de 5kPa) - Temperatura máxima 120°C



TM 3/8



1/2 NPT(E)

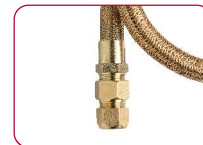

TM 3/8

CÓD.	PRODUTO	CÓD. BAR.	PESO (Kg)	CÓD.	PRODUTO	CÓD. BAR.	PESO (Kg)
279	Flex. 1/2(l) x 1000mm c/ Adaptador Aperto Rápido Duplo - Emb. Ind.	7908212305438	0,384	1482	Kit Gás Dom. Flex Tomback 1/2(l) x 1000mm c/ Registro Esfera - Emb. Ind.	7908212310302	0,561
				10536	Kit Gás Dom. Flex Tomback 1/2(l) x 1200mm c/ Registro Esfera - Emb. Ind.	7898586671775	0,619

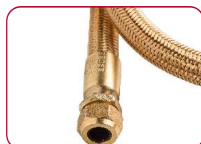

TM 3/8

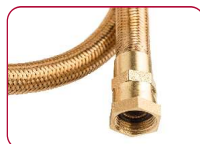

1/2 BSP(l)

CÓD.	PRODUTO	CÓD. BAR.	PESO (Kg)
791	Flex. 1/2(l) x 1000mm R. 1/2 BSP (l) x Adaptador Aperto Rápido - Emb. Ind.	7898586675292	0,367
792	Flex. 1/2(l) x 1200mm R. 1/2 BSP (l) x Adaptador Aperto Rápido - Emb. Ind.	7898586675308	0,407
1095	Flex. 1/2(l) x 1500mm R. 1/2 BSP (l) x Adaptador Aperto Rápido - Emb. Ind.	7908212309160	0,509
1096	Flex. 1/2(l) x 2000mm R. 1/2 BSP (l) x Adaptador Aperto Rápido - Emb. Ind.	7908212309177	0,678

Mangueira Nitrílica GLP/GN c/ Trama de Aço Inox 304 para Instalações de Gás conforme NBR 14955

14 bar pressão máxima de trabalho - Temperatura Máxima 120°

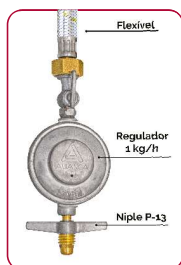

TM 3/8



1/2 NPT(E)



TM 3/8



CÓD.	PRODUTO	CÓD. BAR.	PESO (Kg)	CÓD.	PRODUTO	CÓD. BAR.	PESO (Kg)
10522	Kit para Gás Doméstico c/ Flex. Mang. 3/8(l) x 1200 mm - Emb. Ind.	7898586671768	0,731	1455	Kit Gás Dom. Flex. Mang. 3/8(l) x 1000mm c/ Reg. Esfera - Emb. Ind.	7908212310425	0,512
				762	Kit Gás Dom. Flex. Mang. 3/8(l) x 1200mm c/ Reg. Esfera - Emb. Ind.	7908212310449	0,585



Mangueira Nitrílica GLP/GN com Trama de Latão Tombac para Instalações de Gás conforme NBR 14955

14 bar pressão máxima de trabalho - Temperatura Máxima 120°



1/2 BSP(I)



1/2 NPT(E)



EMBALAGEM INDIVIDUAL

BAIXA PRESSÃO

CÓD.	PRODUTO	CÓD. BAR.	PESO (Kg)
10555	Flexível Ø3/8 (I) x 400mm - R. 1/2 NPT (E) x 1/2 BSP (I)	7898586671805	0,223
10557	Flexível Ø3/8 (I) x 1000mm - R. 1/2 NPT (E) x 1/2 BSP (I)	7898586671829	0,397
10554	Flexível Ø3/8 (I) x 1200mm - R. 1/2 NPT (E) x 1/2 BSP (I)	7898586671836	0,477
10558	Flexível Ø3/8 (I) x 1500mm - R. 1/2 NPT (E) x 1/2 BSP (I)	7898586671843	0,535
10559	Flexível Ø3/8 (I) x 2000mm - R. 1/2 NPT (E) x 1/2 BSP (I)	7898586671850	0,673

Mangueira Nitrílica 3/8 GLP/GN com Trama de Latão Tombac para Instalações de Gás conforme NBR 13419



TM 3/8



POL 7/8 (E)



1/2 NPT(E)



CÓD.	PRODUTO	CÓD. BAR.	PESO (Kg)	CÓD.	PRODUTO	CÓD. BAR.	PESO (Kg)
900	Flexível Ø3/8(I) x 1200mm Ponta/Ponta - Emb. Ind.	7908212308583	0,434	10541	Flexível Ultragaz 1000mm c/ Trançado Tombac - R.1/2 NPT(E) x POL 7/8(E) - Emb. Ind.	7898586671973	0,417

Mangueira Nitrílica GLP/GN com Trama de Aço Inox 304 para Instalações de Gás conforme NBR 14955

Maqenge[®]



14 bar pressão máxima de trabalho - Temperatura Máxima 120° C



1/2 BSP(I)

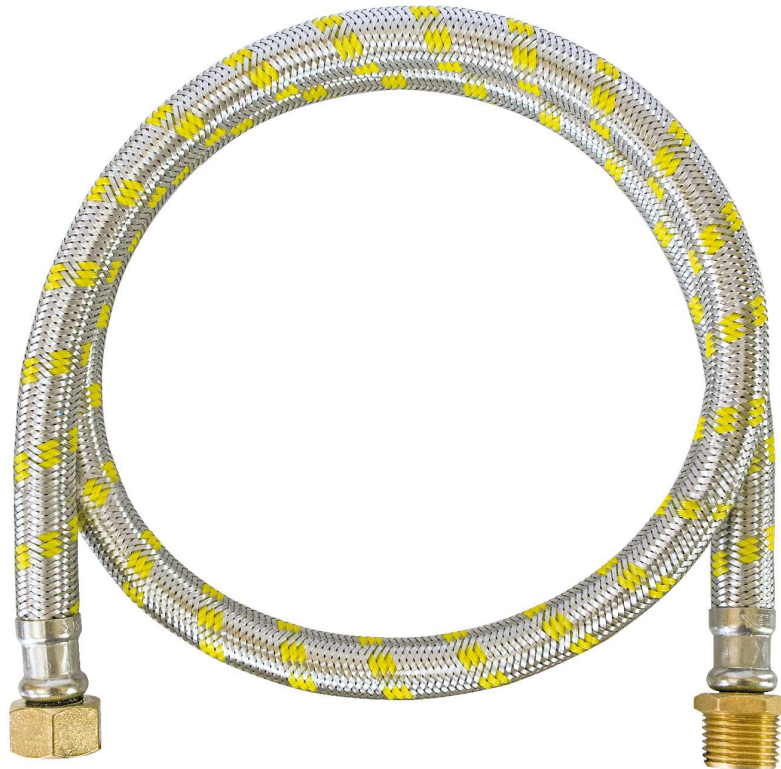

1/2 NPT(E)



EMBALAGEM INDIVIDUAL

CÓD.	PRODUTO	CÓD. BAR.	PESO (Kg)
9697	Flexível Ø3/8 (I) x 300mm - R. 1/2 NPT(E) x 1/2 BSP(I)	7898586678651	0,163
1370	Flexível Ø3/8 (I) x 400mm - R. 1/2 NPT(E) x 1/2 BSP(I)	7908212309948	0,131
9696	Flexível Ø3/8 (I) x 500mm - R. 1/2 NPT(E) x 1/2 BSP(I)	7908212305155	0,212
1371	Flexível Ø3/8 (I) x 800mm - R. 1/2 NPT(E) x 1/2 BSP(I)	7908212309955	0,192
1372	Flexível Ø3/8 (I) x 1000mm - R. 1/2 NPT(E) x 1/2 BSP(I)	7908212309962	0,223
1374	Flexível Ø3/8 (I) x 1200mm - R. 1/2 NPT(E) x 1/2 BSP(I)	7908212309979	0,338
1375	Flexível Ø3/8 (I) x 1500mm - R. 1/2 NPT(E) x 1/2 BSP(I)	7908212309986	0,400
1376	Flexível Ø3/8 (I) x 2000mm - R. 1/2 NPT(E) x 1/2 BSP(I)	7908212309993	0,500
8477	Flexível Ø3/8 (I) x 2500mm - R. 1/2 NPT(E) x 1/2 BSP(I)	7898586671331	0,714
8479	Flexível Ø3/8 (I) x 3000mm - R. 1/2 NPT(E) x 1/2 BSP(I)	7898586671348	0,834
8483	Flexível Ø3/8 (I) x 4000mm - R. 1/2 NPT(E) x 1/2 BSP(I)	7898586671362	1,095



Mangueira Nitrílica 3/8 GLP/GN com Trama de Aço Inox 304 para Instalações de Gás

14 bar pressão máxima de trabalho - Temperatura Máxima 120°



TM 3/8



EMBALAGEM INDIVIDUAL

CÓD.	PRODUTO	CÓD. BAR.	PESO (Kg)
10745	Flexível Ø3/8 (I) x 800mm - Ponta/Ponta	7898586672062	0,243
10746	Flexível Ø3/8 (I) x 1000mm - Ponta/Ponta	7898586672079	0,290
10747	Flexível Ø3/8 (I) x 1200mm - Ponta/Ponta	7898586672086	0,366
707	Flexível Ø3/8 (I) x 1500mm - Ponta/Ponta	7898586670631	0,418
710	Flexível Ø3/8 (I) x 2000mm - Ponta/Ponta	7898586670662	0,528
712	Flexível Ø3/8 (I) x 2500mm - Ponta/Ponta	7898586670907	0,680
559	Flexível Ø3/8 (I) x 3000mm - Ponta/Ponta - Embalagem Coletiva	7898586676206	0,845
560	Flexível Ø3/8 (I) x 4000mm - Ponta/Ponta - Embalagem Coletiva	7898586676213	1,050
561	Flexível Ø3/8 (I) x 5000mm - Ponta/Ponta - Embalagem Coletiva	7898586676220	1,408
562	Flexível Ø3/8 (I) x 6000mm - Ponta/Ponta - Embalagem Coletiva	7898586676237	1,690

Mangueira Nitrílica GLP/GN com Trama de Aço Inox 304 para Instalações de Gás conforme NBR 14955

14 bar pressão máxima de trabalho - Temperatura Máxima 120°

Miaqenge[®]

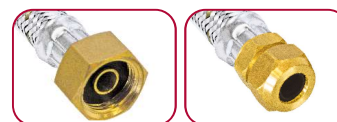

1/2 BSP(I)

TM 3/8



CÓD.	PRODUTO	CÓD. BAR.	PESO (Kg)
9977	Flexível Ø3/8 (I) x 800mm - R. 1/2 BSP(I) x Adaptador Aperto Rápido - Emb. Ind.	7898586671416	0,297
9978	Flexível Ø3/8 (I) x 1000mm - R. 1/2 BSP(I) x Adaptador Aperto Rápido - Emb. Ind.	7898586671423	0,348
9979	Flexível Ø3/8 (I) x 1200mm - R. 1/2 BSP(I) x Adaptador Aperto Rápido - Emb. Ind.	7898586671430	0,398
9980	Flexível Ø3/8 (I) x 1500mm - R. 1/2 BSP(I) x Adaptador Aperto Rápido - Emb. Ind.	7898586671447	0,477

Mangueira Nitrílica 3/8 GLP/GN com Trama de Aço Inox 304 para Instalações de Gás conforme NBR 13419

14 bar pressão máxima de trabalho - Temperatura Máxima 120°



1/2 BSP(I)

TM 3/8

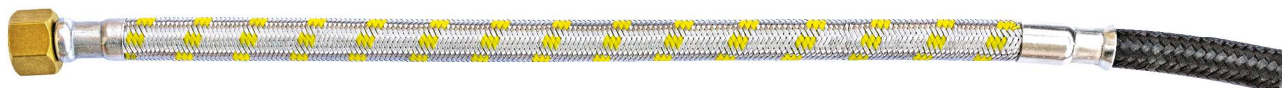

CÓD.	PRODUTO	CÓD. BAR.	PESO (Kg)
713	Flexível 5/8 (E) x 3/8(I) x 1000mm - R.1/2 BSP(I) x Ponta - Emb. Ind.	7898586670808	0,331
711	Flexível 5/8 (E) x 3/8(I) x 1200mm - R.1/2 BSP(I) x Ponta - Emb. Ind.	7898586670648	0,397
714	Flexível 5/8 (E) x 3/8(I) x 2000mm - R.1/2 BSP(I) x Ponta - Emb. Ind.	7898586670891	0,662

Ligações Flexíveis para Instalação de Gás GLP/GN em redes e equipamentos conforme NBR 13419

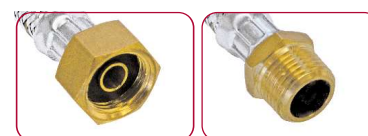

1/2 BSP(I)

1/2 NPT(E)

CÓD.	PRODUTO	CÓD. BAR.	PESO (Kg)
10049	Flexível 3/8 (I) x 1000mm - R.1/2 NPT(E) x 1/2 BSP(I) Baixa/Alta Pressão - Emb. Ind.	7898586671454	0,273
10052	Flexível 3/8 (I) x 1200mm - R.1/2 NPT(E) x 1/2 BSP(I) Baixa/Alta Pressão - Emb. Ind.	7898586671461	0,352
10053	Flexível 3/8 (I) x 1500mm - R.1/2 NPT(E) x 1/2 BSP(I) Baixa/Alta Pressão - Emb. Ind.	7898586671478	0,425

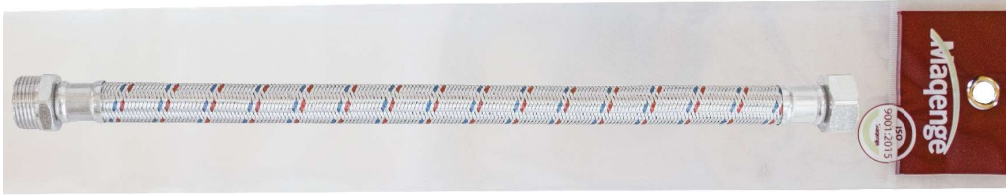

1/2 NPT(E)



3/4 BSP(I)

PASSAGEM PLENA

CÓD.	PRODUTO	CÓD. BAR.	PESO (Kg)
1461	Flexível R. 3/4 BSP(I) x 1/2 NPT(E) x 300mm - Emb. Ind.	7908212310128	0,230
1462	Flexível R. 3/4 BSP(I) x 1/2 NPT(E) x 400mm - Emb. Ind.	7908212310111	0,270



1/2 NPT(E)



1/2 BSP(I)

PASSAGEM PLENA

CÓD.	PRODUTO	CÓD. BAR.	PESO (Kg)
1543	Flexível R. 1/2 BSP(I) x 1/2 NPT(E) x 300mm - Emb. Ind.	7908212310470	0,160
1463	Flexível R. 1/2 BSP(I) x 1/2 NPT(E) x 400mm - Emb. Ind.	7908212310135	0,180
1464	Flexível R. 1/2 BSP(I) x 1/2 NPT(E) x 600mm - Emb. Ind.	7908212310142	0,230



1/2 BSP(I)



1/2 BSP(I)

PASSAGEM REDUZIDA

CÓD.	PRODUTO	CÓD. BAR.	PESO (Kg)
1465	Flexível R. 1/2 BSP(I) x 1/2 BSP(E) x 400mm - Emb. Ind.	7908212310159	0,130
1467	Flexível R. 1/2 BSP(I) x 1/2 BSP(E) x 600mm - Emb. Ind.	7908212310166	0,150
1508	Flexível R. 1/2 BSP(I) x 1/2 BSP(E) x 1000mm - Emb. Ind.	7908212310432	0,170



PARA TOMBACK MAQENGE

CÓD.	PRODUTO	CÓD. BAR.	PESO (Kg)	CÓD.	PRODUTO	CÓD. BAR.	PESO (Kg)
30119	Anel Borracha 19 x 3mm Furo 8,50mm c/ 100 un. - Emb. Ind.	7898586670785	0,080	30134	Anel Borracha 18 x 3mm Furo 13mm c/ 100 un. - Emb. Ind.	7908212309344	0,080



CÓD.	PRODUTO	CÓD. BAR.	PESO (Kg)
30112	Abraçadeira Metál. 12 a 16mm com paraf. sext. c/ 20 un. - Emb. Ind.	7898586672635	0,224

Conjunto para Instalação de Aquecedores Gás / Água Quente e Fria Passagem Plena



1/2 BSP(I) 1/2 NPT(E) 1/2 BSP(I) 1/2 BSPT(E) 1/2 NPT(E)

PASSAGEM PLENA

CÓD.	PRODUTO	CÓD. BAR.	PESO (Kg)
1785	Kit para Instalação 300mm de Água Quente e Fria com Flexível Tomback e Registro - Emb. Ind.	7908212310531	0,625
1474	Kit para Instalação 400mm de Água Quente e Fria com Flexível Tomback e Registro - Emb. Ind.	7908212310173	0,695

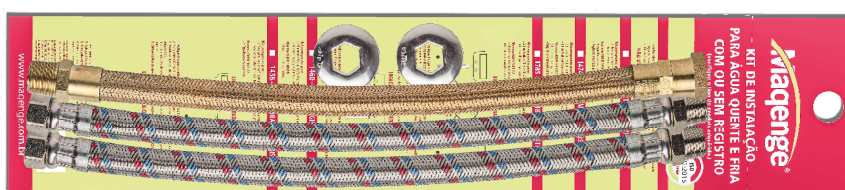

1/2 BSP(I) 1/2 NPT(E) 1/2 BSP(I) 1/2 BSPT(E)

PASSAGEM PLENA

CÓD.	PRODUTO	CÓD. BAR.	PESO (Kg)
1458	Kit para Instalação 400mm de Água Quente e Fria com Flexível Tomback - Emb. Ind.	7908212310180	0,559

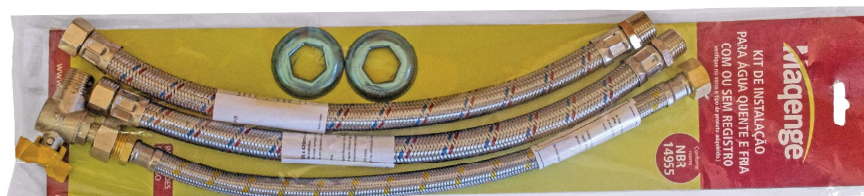

1/2 BSP(I) 1/2 NPT(E) 1/2 BSP(I) 1/2 NPT(E) 1/2 NPT(E)

PASSAGEM PLENA

CÓD.	PRODUTO	CÓD. BAR.	PESO (Kg)
1459	Kit para Instalação 400mm de Água Quente e Fria com Registro - Emb. Ind.	7908212310197	0,676



1/2 BSP(I) 1/2 NPT(E) 1/2 BSP(I) 1/2 NPT(E)

PASSAGEM PLENA

CÓD.	PRODUTO	CÓD. BAR.	PESO (Kg)
1460	Kit para Instalação 400mm de Água Quente e Fria - Emb. Ind.	7908212310203	0,541

LANÇAMENTO



PASSAGEM PLENA



1/2 NPT(E)

1/2 BSP(I)

1/2 NPT(E)

1/2 BSP(I)

3x

CÓD.	PRODUTO	CÓD. BAR.	PESO (Kg)
30148	Kit para Instalação 300mm de Água Quente e Fria com Flexível Tomback e Registro	7908212310630	0,425
30149	Kit para Instalação 400mm de Água Quente e Fria com Flexível Tomback e Registro	7908212310647	0,500

LANÇAMENTO

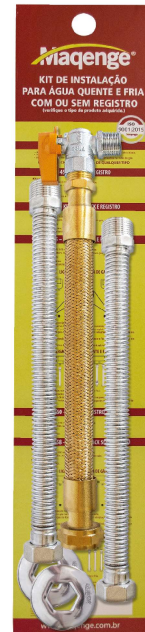

PASSAGEM PLENA



1/2 NPT(E)

3/4 BSP(I)

1/2 NPT(E)

3/4 BSP(I)

3x

CÓD.	PRODUTO	CÓD. BAR.	PESO (Kg)
30147	Kit para Instalação 400mm de Água Quente e Fria 1/2 X 3/4 com Flexível Tomback e Registro	7908212310654	0,520

**Flexível Inox 304 p/ Água Quente e Fria
c/ Passagem Plena**

1,15MPa pressão máxima de trabalho - temperatura máxima -10 + 90°

Miaqenge[®]



LANÇAMENTO

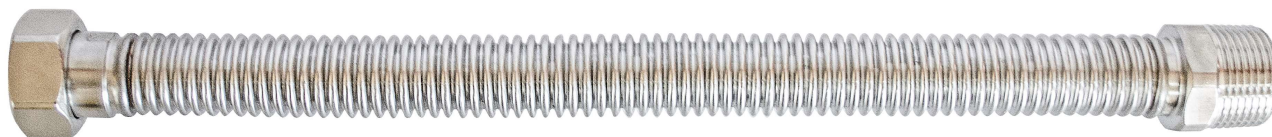

1/2 BSP(I)



1/2 NPT(E)

CÓD.	PRODUTO	CÓD. BAR.	PESO (Kg)
30144	Flexível Corrugado Inox 20,5(E) X 400mm R. 1/2 NPT (E) X R. 1/2 BSP (I)	7908212310593	0,148

LANÇAMENTO

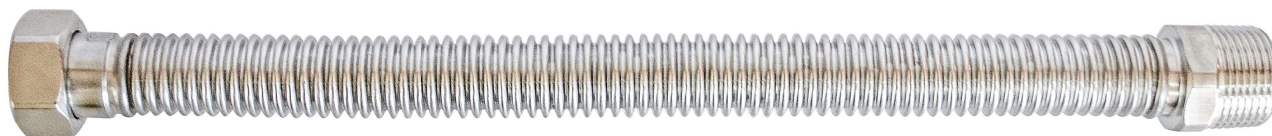

1/2 BSP(I)



1/2 NPT(E)

CÓD.	PRODUTO	CÓD. BAR.	PESO (Kg)
30145	Flexível Corrugado Inox 20,5(E) X 300mm R. 1/2 NPT (E) X R. 1/2 BSP (I)	7908212310609	0,120

LANÇAMENTO

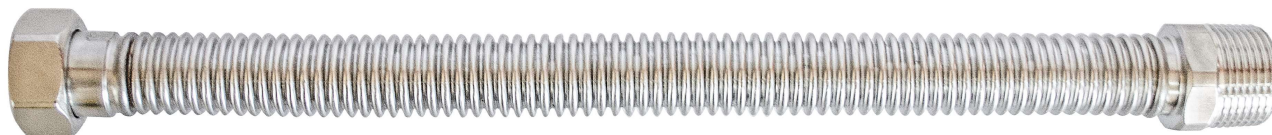

3/4 BSP(I)



1/2 NPT(E)

CÓD.	PRODUTO	CÓD. BAR.	PESO (Kg)
30146	Flexível Corrugado Inox 20,5(E) X 400mm R. 1/2 NPT (E) X R. 3/4 BSP (I)	7908212310616	0,160



1 NPT(E)



1 BSP(I)

LANÇAMENTO

CÓD.	PRODUTO	CÓD. BAR.	PESO (Kg)
30142	Flexível para Água Quente e Fria 1" X 800mm	7908212310579	0,400



3/4 NPT(E)



3/4 BSP(I)

LANÇAMENTO

CÓD.	PRODUTO	CÓD. BAR.	PESO (Kg)
30143	Flexível para Água Quente e Fria 3/4" X 800mm	7908212310586	0,200



1,15MPa pressão máxima de trabalho
temperatura máxima -10 + 90°



POL 7/8 (E)



1/4 NPT(E)



P-13 (2x)

CÓD.	PRODUTO	CÓD. BAR.	PESO (Kg)
9745	Flex. Mangueira Ultragaz 2x P-45 x 1/2 NPT(I) x 2 x 500mm c/ Regulador 2,8kPa Vazão 12 Kg/h - Emb. Ind.	7898586671249	1,304

CÓD.	PRODUTO	CÓD. BAR.	PESO (Kg)
594	Flex. Mangueira 2x P-13 x 1/4 NPT(E) x 500mm x 1000mm c/ Reg. 2,8 kPa Vazão 5 Kg/h - Emb. Ind.	7898586677722	0,880



POL 7/8 (E)



TM 3/8



P-13 (2x)

CÓD.	PRODUTO	CÓD. BAR.	PESO (Kg)
9752	Flex. Mangueira Ultragaz 2x P-45 x 3/8 NPT(I) x 2 x 500mm c/ Regulador 2,8kPa Vazão 7Kg/h - Emb. Ind.	7898586671270	0,915

CÓD.	PRODUTO	CÓD. BAR.	PESO (Kg)
9738	Flex. Mang. 2x P-13 x Saída BM 3/8 x 500mm x 1000mm c/ Regulador 2,8 kPa - Vazão 5 Kg/h - Emb. Ind.	7898586671225	0,811

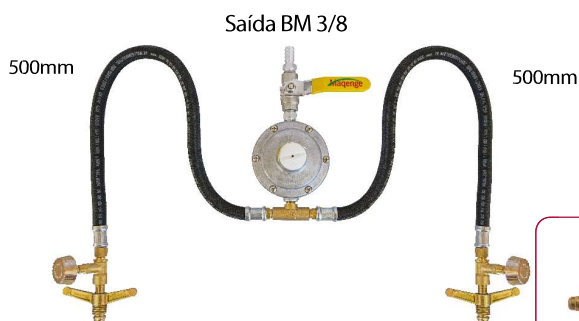

P-13 (2x)



TM 3/8



P-13

CÓD.	PRODUTO	CÓD. BAR.	PESO (Kg)
9753	Flex. Mangueira 2x P-13 x Saída BM 3/8 x 2 x 500mm c/ Reg. 2,8kPa - Vazão 5 Kg/h - Emb. Ind.	7898586671287	0,804

CÓD.	PRODUTO	CÓD. BAR.	PESO (Kg)
10225	Flex. Mangueira P-13 x Saída BM 3/8 x 1500mm c/Reg. 2,8kPa Vazão 5Kg/h - Emb. Ind.	7898586671751	0,670

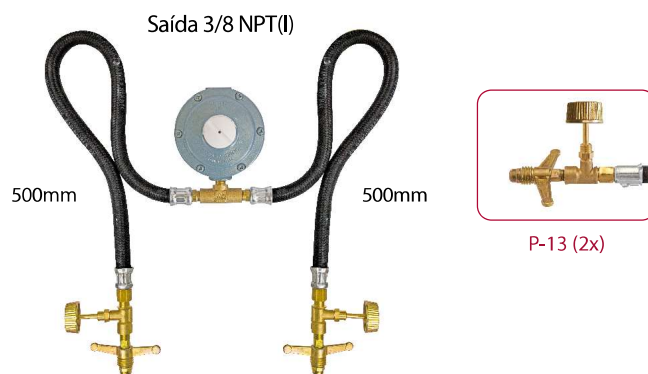

CÓD.	PRODUTO	CÓD. BAR.	PESO (Kg)
10061	Flex. Mang. P-13 x 1/4 NPT(E) x 1000mm c/ Regulador 2,8kPa - Vazão 7Kg/h - Emb. Ind.	7898586671737	0,670

CÓD.	PRODUTO	CÓD. BAR.	PESO (Kg)
9749	Flex. Mang. 2x P-13 x 3/8 NPT(I) x 500mm (2x) c/ Regulador 2,8kPa - Vazão 7Kg/h - Emb. Ind.	7898586671256	0,739

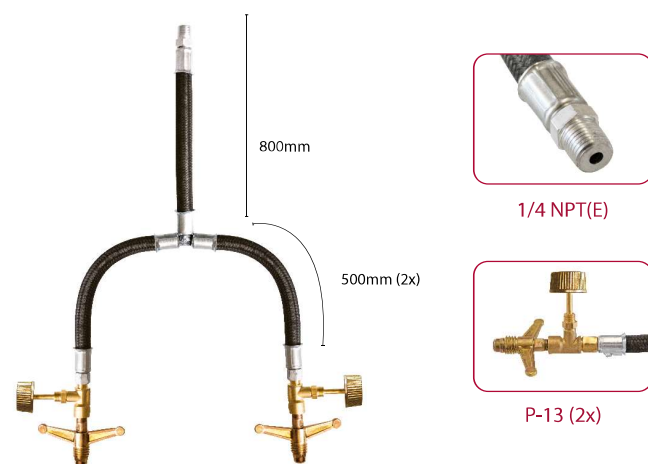
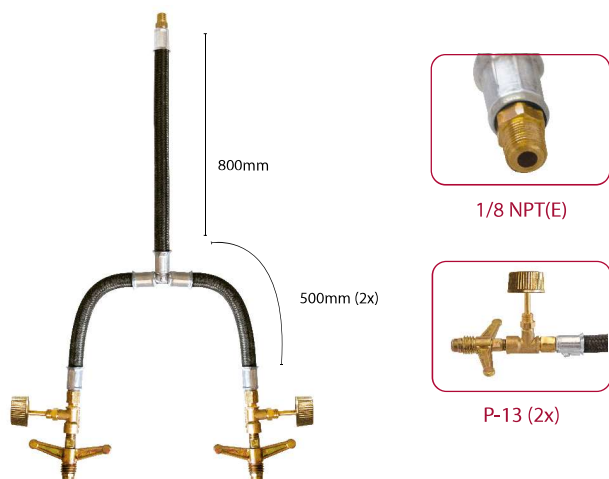

CÓD.	PRODUTO	CÓD. BAR.	PESO (Kg)
6915	Flex. Mang. 1/4 (I) R. P-13 (2x) x 1/8 NPT(E) - Emb. Ind.	7898586671508	0,639

CÓD.	PRODUTO	CÓD. BAR.	PESO (Kg)
6968	Flex. Mag. 1/4 (I) R. P-13 (2X) x 1/4 NPT (E) - Emb. Ind.	7898586671713	0,602

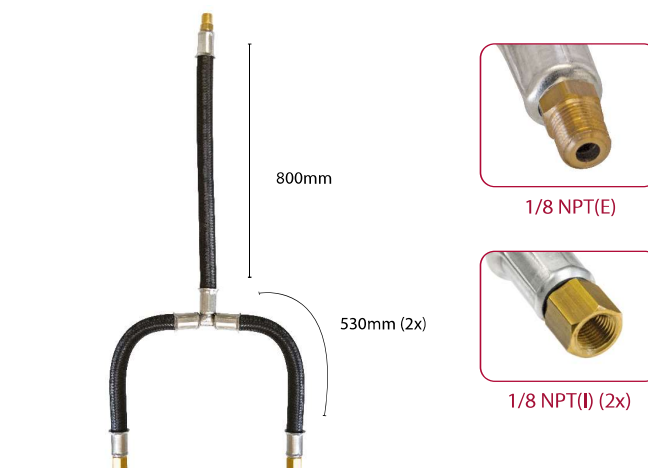

CÓD.	PRODUTO	CÓD. BAR.	PESO (Kg)
8389	Flexível Mangueira 1/4 (I) R. 1/8 NPT(E) (3x) - Emb. Ind.	7898586671492	0,400

CÓD.	PRODUTO	CÓD. BAR.	PESO (Kg)
6789	Flex. Mang. 1/4 (I) R. 1/8 NPT(I) (2x) x 1/8 NPT(E) - Emb. Ind	7898586671485	0,392



7/16 UNS (E)



POL 7/8 (E)



1/8 NPT(E)



1/8 NPT(I)



CÓD.	PRODUTO	CÓD. BAR.	PESO (Kg)
4017	Flex. Mang. Ultragaz 1/4 (I) x 500mm R. 7/16 UNS (E) x POL 7/8 (E)	7898586671546	0,199
10593	Flex. Mang. Ultragaz 1/4 (I) x 800mm R. 7/16 UNS (E) x POL 7/8 (E)	7898586672000	0,268
4166	Flex. Mang. Ultragaz 1/4 (I) x 1000mm R. 7/16 UNS (E) x POL 7/8 (E)	7898586671607	0,290

CÓD.	PRODUTO	CÓD. BAR.	PESO (Kg)
7291	Flex. P-13 Mang. 1/4 (I) x 500mm R. 1/8 NPT(E) x 1/8 NPT(I)	7898586671614	0,132
10591	Flex. P-13 Mang. 1/4 (I) x 800mm R. 1/8 NPT(E) x 1/8 NPT(I)	7898586672055	0,177
7292	Flex. P-13 Mang. 1/4 (I) x 1000mm R. 1/8 NPT(E) x 1/8 NPT(I)	7898586671621	0,212
8012	Flex. P-13 Mang. 1/4 (I) x 1500mm R. 1/8 NPT(E) x 1/8 NPT(I)	7898586671645	0,317



7/16 UNS (E)



1/8 NPT(I)



CÓD.	PRODUTO	CÓD. BAR.	PESO (Kg)
4019	Flexível P-13 Mangueira 1/4 (I) x 500mm - R. 7/16 UNS(E) x 1/8 NPT(I)	7898586671560	0,138
4018	Flexível P-13 Mangueira 1/4 (I) x 800mm - R. 7/16 UNS(E) x 1/8 NPT(I)	7898586671553	0,183
4020	Flexível P-13 Mangueira 1/4 (I) x 1000mm - R. 7/16 UNS(E) x 1/8 NPT(I)	7898586671577	0,219



**NITRÍLICA |
CONFORME
NBR 13419**

*Rolo Fechado com 50 metros



CÓD.	PRODUTO	PESO (Kg)
10071	Mang. Multicombustível 5/8 (E) x 3/8 (I) p/ GLP/GN	0,176
10301	Mang. Multicombustível 9/16 (E) x 5/16 (I) p/ GLP/GN	0,157
6775	Mang. Multicombustível 9/16 (E) x 1/4 (I) p/ GLP/GN	0,161

CÓD.	PRODUTO	PESO (Kg)
9712	Meia Luva de Aço Tridolete R. 1/2 NPT(I)	0,064



Reguladores para Instalações de Gás GLP/GN em Redes e Equipamentos



CÓD.	PRODUTO	CÓD. BAR.	PESO (Kg)
9751	Vazão 7 Kg/h - 2,8kPa - Entrada R. 1/8 NPT(I) Saída R. 3/8 NPT(I)	7891249057817	0,237



CÓD.	PRODUTO	CÓD. BAR.	PESO (Kg)
9757	Vazão 12 Kg/h - 2,8kPa - Entrada R. 1/2 NPT(I) Saída R. 1/2 NPT(I)	7891249031978	0,660



CÓD.	PRODUTO	CÓD. BAR.	PESO (Kg)
10403	Vazão 5 Kg/h - 2,8kPa - Entrada R. 1/8 NPT(I) Saída R. 1/4 NPT(I)	7891249057800	0,187



CÓD.	PRODUTO	CÓD. BAR.	PESO (Kg)
10521	Vazão 1Kg/h - 2,8kPa - Ent. P-13 (R. 5/8 UNC) - Saída R. 1/2 BSP(E)	7891249058685	0,266

Ligações Flexíveis P-13 Mangueira com Registro para Instalações de Gás GLP/GN em Redes e Equipamentos Conforme NBR 13419



CÓD.	PRODUTO	CÓD. BAR.	PESO (Kg)
8106	1/4 (I) x 1000mm R. P-13 x 1/8 NPT(E)	7898586671652	0,306
8110	1/4 (I) x 1500mm R. P-13 x 1/8 NPT(E)	7898586671676	0,396

CÓD.	PRODUTO	CÓD. BAR.	PESO (Kg)
8107	1/4 (I) x 1000mm R. P-13 x 1/8 NPT(I)	7898586671669	0,320
7460	1/4 (I) x 1500mm R. P-13 x 1/8 NPT(I)	7898586671638	0,402



CÓD.	PRODUTO	CÓD. BAR.	PESO (Kg)
10045	1/4 (I) x 1000mm R. P-13 x 1/4 NPT(E)	7898586671706	0,378
10034	1/4 (I) x 1200mm R. P-13 x 1/4 NPT(E)	7898586671690	0,400
10033	1/4 (I) x 1500mm R. P-13 x 1/4 NPT(E)	7898586671683	0,434

CÓD.	PRODUTO	CÓD. BAR.	PESO (Kg)
10248	1/4 (I) x 1000mm R. P-13 x Saída TM 1/4	7898586672345	0,297
248	1/4 (I) x 1500mm R. P-13 x Saída TM 1/4	7898586672338	0,400
10303	5/16 (I) x 1000mm R. P-13 x Saída TM 5/16	7898586672291	0,273
246	5/16 (I) x 1500mm R. P-13 x Saída TM 5/16	7898586672307	0,379

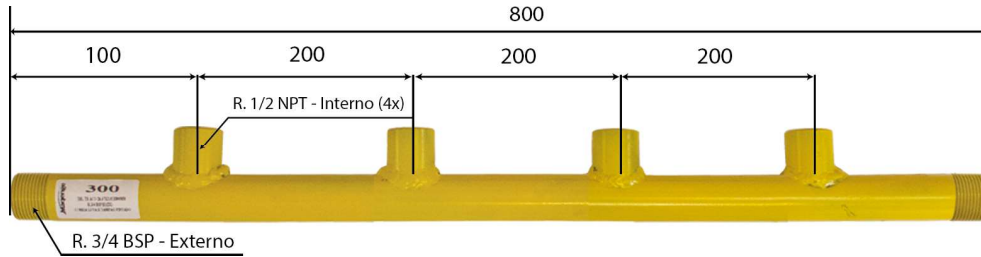

CÓD.	PRODUTO	CÓD. BAR.	PESO (Kg)
300	Coletor de Gás 3/4 x 800 x 800mm com 04 Saídas R. 1/2 NPT(I)	7898586673755	2,037

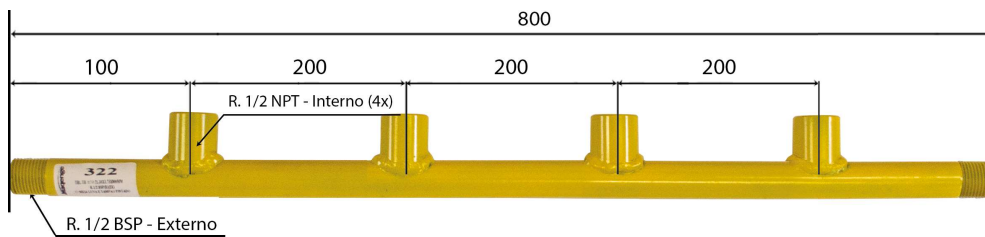

CÓD.	PRODUTO	CÓD. BAR.	PESO (Kg)
322	Coletor de Gás 1/2 x 800mm com 04 Saídas R. 1/2 NPT(I)	7898586673847	1,597

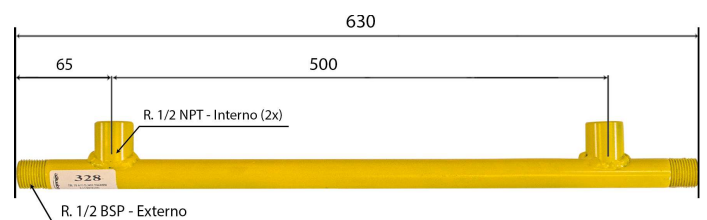
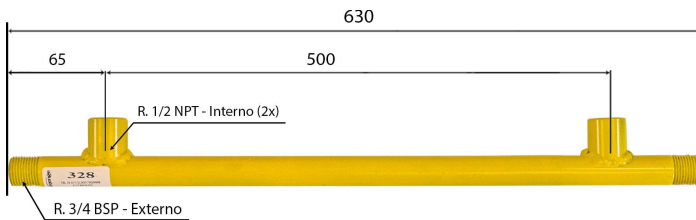

CÓD.	PRODUTO	CÓD. BAR.	PESO (Kg)
314	Coletor de Gás 3/4 x 630mm com 02 Saídas R. 1/2 NPT(I)	7898586673830	1,512

CÓD.	PRODUTO	CÓD. BAR.	PESO (Kg)
328	Coletor de Gás 1/2 x 630mm com 02 Saídas R. 1/2 NPT(I)	7898586673854	1,158

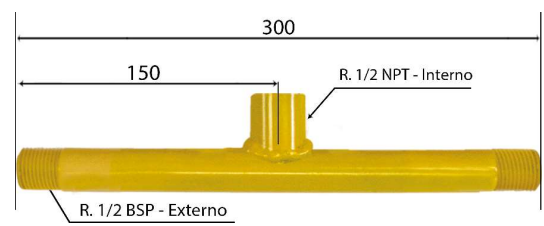
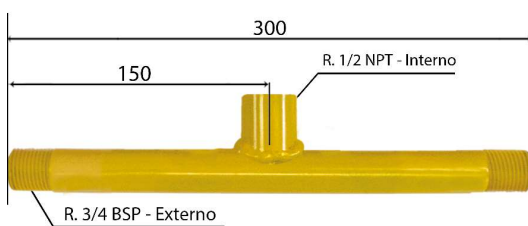

CÓD.	PRODUTO	CÓD. BAR.	PESO (Kg)
428	Coletor de Gás 3/4 x 300mm com 01 Saída R. 1/2 NPT(I)	7898586674370	0,710

CÓD.	PRODUTO	CÓD. BAR.	PESO (Kg)
432	Coletor de Gás 1/2 x 300mm com 01 Saída R. 1/2 NPT(I)	7898586674387	0,548



*Embalagem com 20 unidades

CÓD.	PRODUTO	CÓD. BAR.	PESO (Kg)
30067	PN 25 e DN 15R. 1/2 NPT(I) x 1/2 NPT(E) 90°	7898586670723	0,128



*Embalagem com 20 unidades

CÓD.	PRODUTO	CÓD. BAR.	PESO (Kg)
30017	PN 25 e DN 15 R. 1/2 NPT(E) x 1/2 NPT(E) 90°	7898586670174	0,142

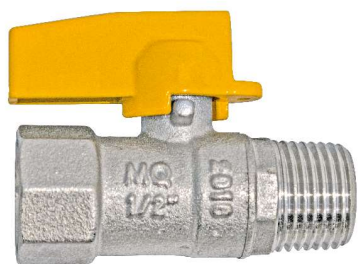

*Embalagem com 15 unidades

CÓD.	PRODUTO	CÓD. BAR.	PESO (Kg)
30019	PN 25 e DN 15 R. 1/2 NPT(E) x 1/2 NPT(I)	7898586670198	0,138



*Embalagem com 15 unidades

CÓD.	PRODUTO	CÓD. BAR.	PESO (Kg)
30018	PN 25 e DN 15 R. 1/2 NPT(E) x 3/8 BM 90°	7898586670181	0,128

Registros de Esfera Manopla Alavanca para Instalações de Gás



*Embalagem com 10 unidades

CÓD.	PRODUTO	CÓD. BAR.	PESO (Kg)
30063	PN 25 e DN 15 R. 1/2 NPT(I) x 1/2 NPT(I)	7898586670686	0,187



*Embalagem com 20 unidades

CÓD.	PRODUTO	CÓD. BAR.	PESO (Kg)
30065	PN 16 e DN 8 R. 1/4 NPT(I) x 1/4 NPT(I)	7898586670709	0,096



*Embalagem com 10 unidades



*Embalagem com 10 unidades

CÓD.	PRODUTO	CÓD. BAR.	PESO (Kg)
30124	R.1/2 NPT(E) x 1/8 NPT(I)	7898586671089	0,092

CÓD.	PRODUTO	CÓD. BAR.	PESO (Kg)
30125	R.1/8 NPT(I) x 1/8 NPT(I)	7898586671096	0,092



*Embalagem com 10 unidades



*Embalagem com 10 unidades

CÓD.	PRODUTO	CÓD. BAR.	PESO (Kg)
30126	R.1/8 NPT(I) x 1/8 NPT(E)	7898586671102	0,085

CÓD.	PRODUTO	CÓD. BAR.	PESO (Kg)
30131	R.1/2 NPT(E) x BM 3/8	7908212308736	0,112

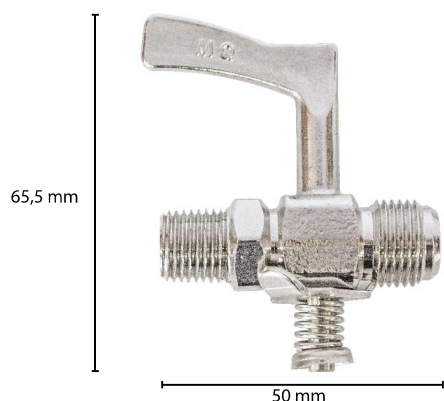

*Embalagem com 10 unidades

CÓD.	PRODUTO	CÓD. BAR.	PESO (Kg)
20048	R. 1/4 BSPT (E) x 1/8 BSP(I) x 3/8 SAE		0,085
30051	R. 1/4 BSPT (E) x 1/8 BSP(I) x 3/8 SAE - Emb. Ind.	7898586670518	0,087

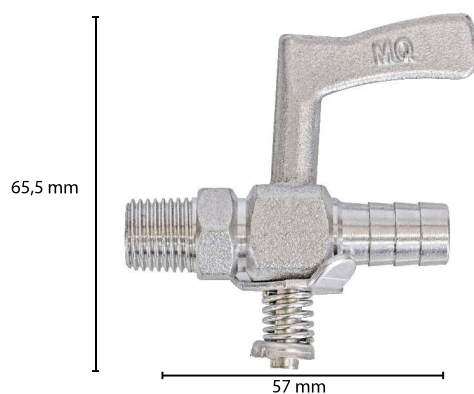

*Embalagem com 10 unidades

CÓD.	PRODUTO	PESO (Kg)
203	R. 1/4 BSPT (E) x 1/8 BSP(I) x BM 3/8	0,080

Registros de Zamac Semi Industrial de Baixa Pressão Cromado

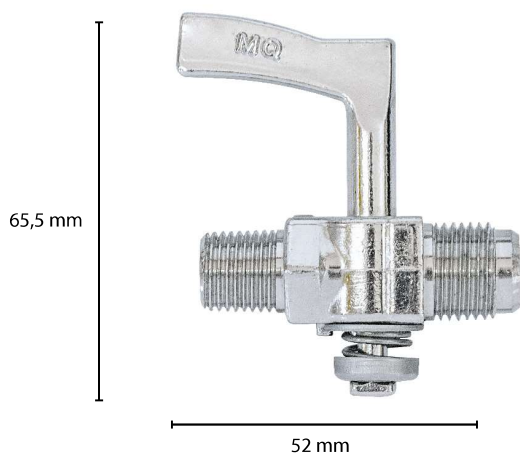

*Embalagem com 20 unidades

CÓD.	PRODUTO	PESO (Kg)
20114	R. 1/4 BSPT (E) x 1/8 BSP(I) x 3/8 SAE	0,070

Registros Ramal Especiais com Haste 44mm para Queimador Infravermelho



CÓD.	PRODUTO	PESO (Kg)
407	R. 1/8 BSPT (E) x M12x1 (E) Fina	0,036



CÓD.	PRODUTO	PESO (Kg)
408	R. 1/8 BSPT (E) x 1/8 BSP(I)	0,032

Registros de Latão Alta Pressão Sistema Agulha Manopla Metal

Maqenge[®]

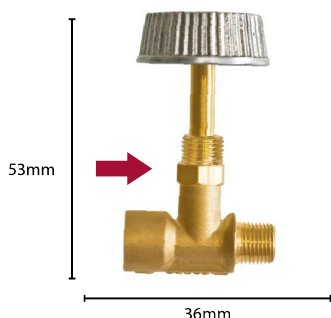

*Embalagem com 15 unidades

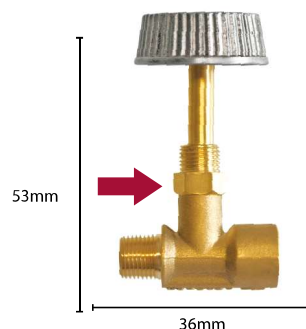

*Embalagem com 15 unidades

CÓD.	PRODUTO	CÓD. BAR.	PESO (Kg)
20005	R. 1/8 NPT(I) x 1/8 NPT(E)		0,064
30006	R. 1/8 NPT(I) x 1/8 NPT(E) Emb. Ind.	7898586670068	0,067

CÓD.	PRODUTO	CÓD. BAR.	PESO (Kg)
20006	R. 1/8 NPT(E) x 1/8 BSP(I)		0,064
30007	R. 1/8 NPT(E) x 1/8 BSP(I) Emb. Ind.	7898586670075	0,066

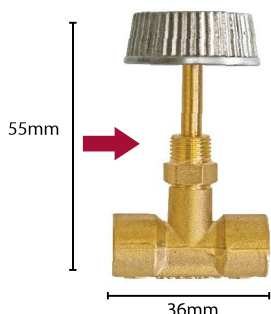

*Embalagem com 15 unidades

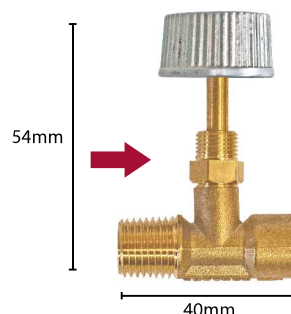

*Embalagem com 15 unidades

CÓD.	PRODUTO	CÓD. BAR.	PESO (Kg)
20008	R. 1/8 NPT(I) x 1/8 NPT(I)		0,067
30008	R. 1/8 NPT(I) x 1/8 NPT(I) Emb. Ind.	7898586670082	0,069

CÓD.	PRODUTO	CÓD. BAR.	PESO (Kg)
20043	R. 1/4 NPT(E) x 1/8 BSP(I)	7908212300136	0,070

Conjunto P-13 com Saída para Mangueira

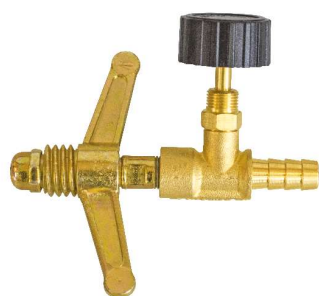

*Embalagem com 15 unidades

CÓD.	PRODUTO	CÓD. BAR.	PESO (Kg)
249	Conj. c/ Niple Borb. e Reg. saída 1/4		0,095
30116	Conj. c/ Niple Borb. e Reg. saída 1/4 - Emb. Ind.	7898586672352	0,098
250	Conj. c/ Niple Borb. e Reg. saída 5/16		0,097
30117	Conj. c/ Niple Borb. e Reg. saída 5/16 - Emb. Ind.	7898586672369	0,099

Registro de Latão Manopla PP

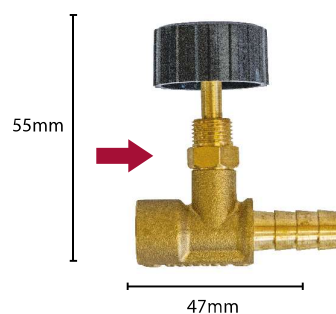

*Embalagem com 15 unidades

CÓD.	PRODUTO	CÓD. BAR.	PESO (Kg)
20105	R. 1/8 NPT(I) x BM 1/4		0,050
30114	R. 1/8 NPT(I) x BM 1/4 Emb. Ind.	7898586672659	0,052
20106	R. 1/8 NPT(I) x BM 5/16		0,052
30115	R. 1/8 NPT(I) x BM 5/16 Emb. Ind.	7898586672666	0,054



LANÇAMENTO *Embalagem com 16 unidades

CÓD.	PRODUTO	CÓD. BAR.	PESO (Kg)
20141	Tee 1/2 NPT(I) x 1/2 NPT(I) x 1/2 NPT(E)		0,092
30136	Tee 1/2 NPT(I) x 1/2 NPT(I) x 1/2 NPT(E) - Emb. Ind.	7908212310210	0,094



LANÇAMENTO *Embalagem com 16 unidades

CÓD.	PRODUTO	CÓD. BAR.	PESO (Kg)
20142	Tee 1/2 NPT(E) x 1/2 NPT(E) x 1/2 NPT(E)		0,087
30137	Tee 1/2 NPT(E) x 1/2 NPT(E) x 1/2 NPT(E) - Emb. Ind.	7908212310227	0,090



LANÇAMENTO *Embalagem com 16 unidades

CÓD.	PRODUTO	CÓD. BAR.	PESO (Kg)
20143	Tee 1/2 NPT(E) x 1/2 NPT(I) x 1/2 NPT(I)		0,089
30138	Tee 1/2 NPT(E) x 1/2 NPT(I) x 1/2 NPT(I) - Emb. Ind.	7908212310234	0,090



*Embalagem com 20 unidades

CÓD.	PRODUTO	CÓD. BAR.	PESO (Kg)
20076	Joelho - R. 1/2 NPT(I) x 1/2 NPT(E)		0,085
30086	Joelho - R. 1/2 NPT(I) x 1/2 NPT(E) - Emb. Ind.	7898586672284	0,087



*Embalagem com 20 unidades

CÓD.	PRODUTO	CÓD. BAR.	PESO (Kg)
20077	Tee - R. 1/2 NPT(I) x 1/2 NPT(I) x 1/2 NPT(I)		0,103
30082	Tee - R. 1/2 NPT(I) x 1/2 NPT(I) x 1/2 NPT(I) - Emb. Ind.	7898586672215	0,104



*Embalagem com 25 unidades

CÓD.	PRODUTO	CÓD. BAR.	PESO (Kg)
20084	Tee - R. 1/2 NPT(E) x BM 3/8 x BM 3/8		0,063
30092	Tee - R. 1/2 NPT(E) x BM 3/8 x BM 3/8 - Emb. Ind.	7908212308835	0,066



CÓD.	PRODUTO	CÓD. BAR.	PESO (Kg)
20180	Luva Emenda R. 1/2 NPT(I) x 1/2 NPT(I)		0,043
30080	Luva Emenda R. 1/2 NPT(I) x 1/2 NPT(I) - Emb. Ind.	7898586672192	0,046



*Embalagem com 20 unidades

CÓD.	PRODUTO	CÓD. BAR.	PESO (Kg)
20085	Joelho - R. 1/2 NPT(I) x 3/8 SAE		0,071
30084	Joelho - R. 1/2 NPT(I) x 3/8 SAE - Emb. Ind.	7898586672239	0,074



*Embalagem com 20 unidades

CÓD.	PRODUTO	CÓD. BAR.	PESO (Kg)
20046	Válvula RF P-13 x 1/2 NPT(E)		0,090
30120	Válvula RF P-13 x 1/2 NPT(E) Emb. Ind.	7898586670860	0,093

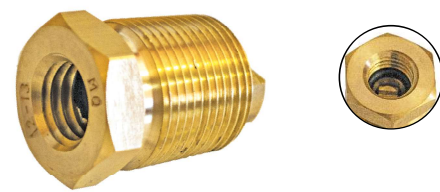

*Embalagem com 20 unidades

CÓD.	PRODUTO	PESO (Kg)
20047	Válvula RF P-13 x 3/4 NPT(E)	0,116

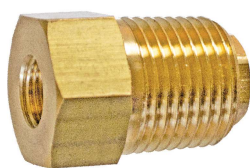

*Embalagem com 30 unidades

CÓD.	PRODUTO	CÓD. BAR.	PESO (Kg)
20011	Válvula de Retenção R. 7/16 UNS (I) x 1/2 NPT(E)		0,075
30013	Válvula de Retenção R. 7/16 UNS (I) x 1/2 NPT(E) Emb. Ind.	7898586670136	0,077



*Embalagem com 20 unidades

CÓD.	PRODUTO	PESO (Kg)
20089	Adaptador Aperto Rápido R. 1/2 NPT(I) x TM 3/8	0,049



*Embalagem com 30 unidades

CÓD.	PRODUTO	CÓD. BAR.	PESO (Kg)
20013	Adaptador Aperto Rápido R. 1/2 BSP(I) x TM 3/8		0,058
30011	Adaptador Aperto Rápido R. 1/2 BSP(I) x TM 3/8 - Emb. Ind.	7898586670112	0,061



*Embalagem com 20 unidades

CÓD.	PRODUTO	CÓD. BAR.	PESO (Kg)
20012	Adaptador Aperto Rápido R. 1/2 BSP(E) x TM 3/8		0,047
30010	Adaptador Aperto Rápido R. 1/2 BSP(E) x TM 3/8 - Emb. Ind.	7898586670105	0,050



*Embalagem com 20 unidades

CÓD.	PRODUTO	CÓD. BAR.	PESO (Kg)
20144	Joelho - R.1/2 BSP(I) x Aperto Rápido TM 3/8		0,097
30139	Joelho - R.1/2 BSP(I) x Aperto Rápido Tm 3/8 - Emb. Ind.	7908212310241	0,100

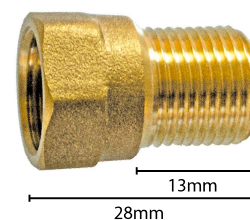

*Embalagem com 25 unidades

CÓD.	PRODUTO	CÓD. BAR.	PESO (Kg)
20107	Alongador Curto - R. 1/2 BSP(E) x 1/2 NPT(I)		0,045
30066	Alongador Curto - R. 1/2 BSP(E) x 1/2 NPT(I) - Emb. Ind.	7898586670716	0,047



*Embalagem com 15 unidades

CÓD.	PRODUTO	PESO (Kg)
20112	R. 5/8 UNC (E) x 1/8 NPT(E) c/ Haste Metal	0,054



*Embalagem com 15 unidades

CÓD.	PRODUTO	PESO (Kg)
3218	R. 5/8 UNC (E) x 1/8 NPT(E)	0,048

Conexões, Niples para Flexíveis P-13 e Porca



CÓD.	PRODUTO	CÓD. BAR.	PESO (Kg)
8078	Niple Latão p/ Flexível P-13 R. 1/8 NPT(E) x 7/16 UNS (I)		0,013
30103	Niple Latão p/ Flexível P-13 R. 1/8 NPT(E) x 7/16 UNS (I) - Emb. Ind	7898586672543	0,015



CÓD.	PRODUTO	CÓD. BAR.	PESO (Kg)
8068	Niple Latão p/ Flexível P-13 R. 7/16 UNS (E) x 1/8 NPT(I)		0,015
30102	Niple Latão p/ Flexível P-13 R. 7/16 UNS (E) x 1/8 NPT(I) Emb. Ind.	7898586672536	0,048



*Embalagem com 25 unidades

CÓD.	PRODUTO	CÓD. BAR.	PESO (Kg)
20019	Tee - R. 1/8 NPT(E) x 1/8 NPT(I) x 1/8 NPT(I)		0,032
30016	Tee - R. 1/8 NPT(E) x 1/8 NPT(I) x 1/8 NPT(I) - Emb. Ind.	7898586670167	0,035



CÓD.	PRODUTO	CÓD. BAR.	PESO (Kg)
20018	Tee - R. 1/8 NPT(I) x 1/8 NPT(I) x 1/8 NPT(I) - Emb. Col.		0,038
30015	Tee - R. 1/8 NPT(I) x 1/8 NPT(I) x 1/8 NPT(I) - Emb. Ind.	7898586670150	0,042



*Embalagem com 25 unidades

CÓD.	PRODUTO	CÓD. BAR.	PESO (Kg)
20014	Joelho - R. 1/8 NPT(E) x 1/8 NPT(I)		0,030
30012	Joelho - R. 1/8 NPT(E) x 1/8 NPT(I) - Emb. Ind.	7898586670129	0,032



*Embalagem com 25 unidades

CÓD.	PRODUTO	CÓD. BAR.	PESO (Kg)
20078	Tee - R. 1/8 NPT(I) x 1/8 NPT(I) x 1/8 NPT(E)		0,040
30110	Tee - R. 1/8 NPT(I) x 1/8 NPT(I) x 1/8 NPT(E) - Emb. Ind.	7908212308842	0,043

Terminais de Latão para Mangueiras (espigas) para Linha a Gás

Miaqenge®



CÓD.	PRODUTO	CÓD. BAR.	PESO (Kg)
10048	Espiga - R. 1/2 NPT(E) x BM 1/2		0,045
20118	Espiga - R. 1/2 NPT(E) x BM 3/8		0,045
30039	Espiga - R. 1/2 NPT(E) x BM 3/8 Emb. Ind.	7898586670396	0,047



CÓD.	PRODUTO	CÓD. BAR.	PESO (Kg)
2616	Espiga - R. 1/2 BSP(E) x BM 3/8		0,041
30035	Espiga - R. 1/2 BSP(E) x BM 3/8 Emb. Ind.	7898586670358	0,042



CÓD.	PRODUTO	CÓD. BAR.	PESO (Kg)
2609	Espiga - R. 1/4 NPT(E) x BM 3/8		0,026
30032	Espiga - R. 1/4 NPT(E) x BM 3/8 Emb. Ind.	7898586670327	0,027



CÓD.	PRODUTO	CÓD. BAR.	PESO (Kg)
2637	Espiga - R. 3/8 NPT(E) x BM 3/8		0,035
30041	Espiga - R. 3/8 NPT(E) x BM 3/8 Emb. Ind.	7898586670419	0,037

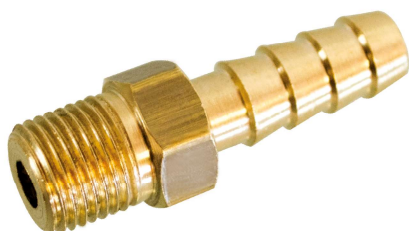

CÓD.	PRODUTO	CÓD. BAR.	PESO (Kg)
2589	Espiga - R. 1/8 NPT(E) x BM 3/8		0,018
30029	Espiga - R. 1/8 NPT(E) x BM 3/8 Emb. Ind.	7898586670297	0,020
2587	Espiga - R. 1/8 NPT(E) x BM 5/16		0,018
30028	Espiga - R. 1/8 NPT(E) x BM 5/16 Emb. Ind.	7898586670280	0,019
20183	Espiga - R. 1/8 NPT(E) x BM 1/4		0,012
30057	Espiga - R. 1/8 NPT(E) x BM 1/4 Emb. Ind.	7898586670570	0,014

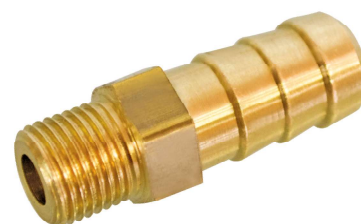

CÓD.	PRODUTO	CÓD. BAR.	PESO (Kg)
2600	Espiga - R. 1/8 BSP(E) x BM 3/8		0,017
30030	Espiga - R. 1/8 BSP(E) x BM 3/8 Emb. Ind.	7898586670303	0,020
4007	Espiga - R. 1/8 BSP(E) x BM 5/16		0,015
7132	Espiga - R. 1/8 BSP(E) x BM 1/4		0,011



CÓD.	PRODUTO	PESO (Kg)
7059	Espiga - R. 7/16 UNS (E) x BM 1/4	0,015



*Embalagem com 25 unidades

CÓD.	PRODUTO	CÓD. BAR.	PESO (Kg)
20049	Tee - BM 3/8 x BM 3/8 x BM 3/8		0,030
30081	Tee - BM 3/8 x BM 3/8 x BM 3/8 - Emb. Ind.	7898586672208	0,031
20051	Tee - BM 1/4 x BM 1/4 x BM 1/4		0,015
30048	Tee - BM 1/4 x BM 1/4 x BM 1/4 - Emb. Ind.	7898586670488	0,016



CÓD.	PRODUTO	CÓD. BAR.	PESO (Kg)
20177	Niple - R. 1/2 NPT(E) x 3/8 NPT(E)		0,052
30076	Niple - R. 1/2 NPT(E) x 3/8 NPT(E) Emb. Ind.	7898586672154	0,054
3055	Niple - R. 1/2 NPT(E) x 1/4 NPT(E)		0,045
30106	Niple - R. 1/2 NPT(E) x 1/4 NPT(E) Emb. Ind.	7898586672574	0,048
3061	Niple - R. 1/2 NPT(E) x 1/8 NPT(E)		0,040
30105	Niple - R. 1/2 NPT(E) x 1/8 NPT(E) Emb. Ind.	7898586672567	0,042
3042	Niple - R. 3/8 NPT(E) x 1/4 NPT(E)		0,036
30104	Niple - R. 3/8 NPT(E) x 1/4 NPT(E) Emb. Ind.	7898586672550	0,038
3044	Niple - R. 3/8 NPT(E) x 1/8 NPT(E)		0,030
20178	Niple - R. 1/4 NPT(E) x 1/8 NPT(E)		0,023
3051	Niple - R. 1/4 NPT(E) x 1/8 BSP(E)		0,025



CÓD.	PRODUTO	CÓD. BAR.	PESO (Kg)
20119	Niple - R. 1/2 NPT(E) x 1/2 NPT(E)		0,052
30075	Niple - R. 1/2 NPT(E) x 1/2 NPT(E) Emb. Ind.	7898586672147	0,054
3022	Niple - R. 3/8 NPT(E) x 3/8 NPT(E)		0,040
20185	Niple - R. 1/4 NPT(E) x 1/4 NPT(E)		0,026
3019	Niple - R. 1/8 NPT(E) x 1/8 NPT(E)		0,010

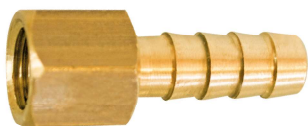

CÓD.	PRODUTO	CÓD. BAR.	PESO (Kg)
2575	Espiga - R. 1/8 NPT(I) x BM 3/8		0,020
30027	Espiga - R. 1/8 NPT(I) x BM 3/8 Emb. Ind.	7898586670273	0,022
971	Espiga - R. 1/8 NPT(I) x BM 5/16		0,015
30025	Espiga - R. 1/8 NPT(I) x BM 5/16 Emb. Ind.	7898586670259	0,017
20184	Espiga - R. 1/8 NPT(I) x BM 1/4		0,011
30056	Espiga - R. 1/8 NPT(I) x BM 1/4 Emb. Ind.	7898586670563	0,013



CÓD.	PRODUTO	CÓD. BAR.	PESO (Kg)
20175	Conexão - R. 3/4 BSP(I) x 1/2 BSP(E)		0,066
30141	Conexão - R. 3/4 BSP(I) x 1/2 BSP(E) - Emb. Ind.	7908212310524	0,068
20179	Conexão - R. 3/4 BSP(E) x 1/2 BSP(I)		0,045
30150	Conexão - R. 3/4 BSP(I) x 1/2 BSP(E) - Emb. Ind.	7908212310661	0,070
3196	Conexão - R. 1/2 NPT(E) x 3/8 NPT(I)		0,026
30098	Conexão - R. 1/2 NPT(E) x 3/8 NPT(I) - Emb. Ind.	7898586672499	0,028
20182	Conexão - R. 1/2 NPT(E) x 1/8 NPT(I)		0,040
30097	Conexão - R. 1/2 NPT(E) x 1/8 NPT(I) - Emb. Ind.	7898586672482	0,043
3194	Conexão - R. 3/8NPT(E) x R. 1/4NPT(I)		0,017
30140	Conexão - R. 3/8NPT(E) x R. 1/4NPT(I) - Emb. Ind.	7908212310487	0,019
3195	Conexão - R. 1/2 NPT(E) x 1/4 NPT(I)		0,042
30096	Conexão - R. 1/2 NPT(E) x 1/4 NPT(I) - Emb. Ind.	7898586672475	0,048
3238	Conexão - R. 3/8 NPT(E) x 1/8 NPT(I)		0,028
30095	Conexão - R. 3/8 NPT(E) x 1/8 NPT(I) - Emb. Ind.	7898586672468	0,030
3192	Conexão - R. 1/4 NPT(E) x 1/8 NPT(I)		0,012
30099	Conexão - R. 1/4 NPT(E) x 1/8 NPT(I) - Emb. Ind.	7898586672505	0,014

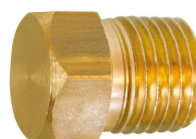

CÓD.	PRODUTO	CÓD. BAR.	PESO (Kg)
2833	Tampão - R. 1/2 NPT(E)		0,045
30046	Tampão - R. 1/2 NPT(E) - Emb. Ind.	7898586670464	0,047
2825	Tampão - R. 1/4 NPT(E)		0,025
30044	Tampão - R. 1/4 NPT(E) - Emb. Ind.	7898586670440	0,027
2831	Tampão - R. 1/8 NPT(E)		0,010
30045	Tampão - R. 1/8 NPT(E) - Emb. Ind.	7898586670457	0,012

*Embalagem com 20 unidades



CÓD.	PRODUTO	CÓD. BAR.	PESO (Kg)
20135	Espiga - R.1/2 NPT (I) x BM 3/8		0,042
30077	Espiga - R.1/2 NPT (I) x BM 3/8 Emb. Ind.	7898586672161	0,043

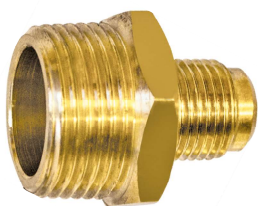

CÓD.	PRODUTO	CÓD. BAR.	PESO (Kg)
10159	Niple - R. 3/4 NPT(E) x 1/2 SAE		0,066
20095	Niple - R. 3/4 NPT(E) x 3/8 SAE		0,065
30101	Niple - R. 3/4 NPT(E) x 3/8 SAE Emb. Ind.	7898586672529	0,067
3066	Niple - R. 1/2 NPT(E) x 1/2 SAE		0,052
30107	Niple - R. 1/2 NPT(E) x 1/2 SAE Emb. Ind.	7898586672581	0,054
20104	Niple - R. 1/2 NPT(E) x 3/8 SAE		0,050
30049	Niple - R. 1/2 NPT(E) x 3/8 SAE Emb. Ind.	7898586670495	0,052
3015	Niple - R. 3/8 NPT(E) x 3/8 SAE		0,038
30074	Niple - R. 3/8 NPT(E) x 3/8 SAE Emb. Ind.	7898586672130	0,040
3208	Niple - R. 1/4 NPT(E) x 3/8 SAE		0,032
3017	Niple - R. 1/8 NPT(E) x 3/8 SAE		0,030
4818	Niple - R. 1/8 NPT(E) x 1/4 SAE		0,010

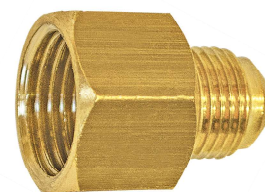

CÓD.	PRODUTO	CÓD. BAR.	PESO (Kg)
10157	Niple - R. 3/4 BSP(I) x 1/2 SAE		0,065
20096	Niple - R. 3/4 BSP(I) x 3/8 SAE		0,063
4030	Niple - R. 1/2 BSP(I) x 3/8 SAE		0,045
30078	Niple - R. 1/2 BSP(I) x 3/8 SAE Emb. Ind.	7898586672178	0,048



CÓD.	PRODUTO	PESO (Kg)
859	Porca Latão Sext. 1/2 x 3mm R. 1/8 BSP(I)	0,002

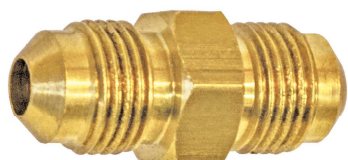

CÓD.	PRODUTO	CÓD. BAR.	PESO (Kg)
4056	Niple - 1/2 SAE x 1/2 SAE		0,058
30108	Niple - 1/2 SAE x 1/2 SAE - Emb. Ind.	7898586672598	0,060
4055	Niple - 3/8 SAE x 3/8 SAE		0,041
30079	Niple - 3/8 SAE x 3/8 SAE - Emb. Ind.	7898586672185	0,043
10532	Niple - 1/4 SAE x 1/4 SAE		0,012
30109	Niple - 1/4 SAE x 1/4 SAE - Emb. Ind.	7898586672604	0,015



CÓD.	PRODUTO	CÓD. BAR.	PESO (Kg)
20176	Porca - 1/2 SAE x R. 3/4 UNF (I)		0,035
30093	Porca - 1/2 SAE x R. 3/4 UNF (I) Emb. Ind.	7898586672451	0,037
20103	Porca - 3/8 SAE x R. 5/8 UNF (I)		0,020
30062	Porca - 3/8 SAE x R. 5/8 UNF (I) Emb. Ind.	7898586670679	0,022
7457	Porca - 1/4 SAE x R. 7/16 UNF (I)		0,017



CÓD.	PRODUTO	PESO (Kg)
942	União 3/8 SAE x 3/8 SAE	0,080
943	União 1/4 SAE x 1/4 SAE	0,045



CÓD.	PRODUTO	CÓD. BAR.	PESO (Kg)
20181	Espiga - 3/8 SAE x BM 3/8		0,031
30055	Espiga - 3/8 SAE x BM 3/8 Emb. Ind.	7898586670556	0,035



*Qtd. mín. por código 10 un.

CÓD.	PRODUTO	PESO (Kg)
2597	Injetor 34mm - R. 1/8 NPT(E) x 1/8 BSP(E)	0,015

(Cód 10742 F. 0,60) (Cód 10777 F. 0,80)
(Cód 10643 F.1,00) (Cód 10778 F.1,20)

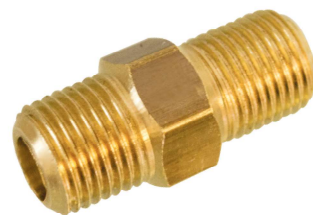

*Qtd. mín. por código 10 un.

CÓD.	PRODUTO	PESO (Kg)
2592	Injetor 25mm - R. 1/8 NPT(E) x 1/8 BSP(E) Passante	0,011



*Qtd. mín. por código 10 un.

CÓD.	PRODUTO	PESO (Kg)
2588	Injetor 20mm - R. 1/8 NPT(E)	0,010

(Cód 10621 F.0,60) (Cód 10788 F. 0,80)
(Cód 10789 F. 1,00) (Cód 10790 F.1,20)



*Qtd. mín. por código 10 un.

CÓD.	PRODUTO	PESO (Kg)
1326	Injetor 35mm - R. 1/8 BSP(E) x 1/8 BSP(E)	0,016

(Cód 10626 F. 0,60) (Cód 10761 F. 0,70)
(Cód 10625 F.1,00) (Cód 622 F.1,20)



*Qtd. mín. por código 10 un.

CÓD.	PRODUTO	PESO (Kg)
2608	Injetor 25mm - R. 1/8 BSP(E) x 1/8 BSP(E) Passante	0,010

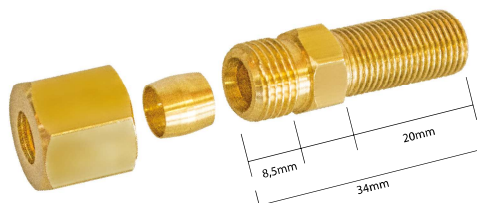

CÓD.	PRODUTO	PESO (Kg)
946	Conjunto Injetor - R. 1/8 BSP(E) para Tubo 1/4 - F.0,85	0,025
954	Conjunto Injetor - R. 1/8 BSP(E) para Tubo 1/4 - F.0,90	0,025

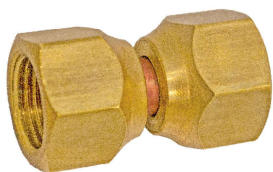

CÓD.	PRODUTO	PESO (Kg)
10535	União Giratória 3/8 SAE x 3/8 SAE	0,045



CÓD.	PRODUTO	PESO (Kg)
7807	Conjunto Porca Anilha e Niple com R. 1/8 NPT(E) para Tubo 1/4	0,017



Qtd. mín. por código 10 un.

CÓD.	PRODUTO	PESO (Kg)
975	Injetor 70mm - R. 1/8 BSP(E) x 1/8 BSP(E) (Cód. 10619 F.0,60) (Cód. 7287 F.0,80) (Cód. 10650 F.0,95) (Cód. 400 F.1,10)	0,027
2577	Injetor 52mm - R. 1/8 BSP(E) x 1/8 BSP(E) (Cód. 10741 F.0,60) (Cód. 269 F.0,80) (Cód. 154 F.0,90) (Cód. 516 F.1,20)	0,020
2594	Injetor 40mm - R. 1/8 BSP(E) x 1/8 BSP(E) (Cód. 10743 F.0,60) (Cód. 10774 F.0,80) (Cód. 10647 F.0,95) (Cód. 10642 F.1,20)	0,016
2604	Injetor 34mm - R. 1/8 BSP(E) x 1/8 BSP(E) (Cód. 10616 F.0,60) (Cód. 7406 F.0,80) (Cód. 7427 F.0,90) (Cód. 10785 F.1,20)	0,013
6917	Injetor 32mm - R. 1/8 BSP(E) x 1/8 BSP(E) (Cód. 186 F.0,60) (Cód. 6880 F.0,85) (Cód. 6881 F.0,95) (Cód. 6874 F.1,20)	0,013
2590	Injetor 25mm - R. 1/8 BSP(E) x 1/8 BSP(E) (Cód. 10615 F.0,60) (Cód. 10779 F.0,80) (Cód. 7408 F.0,90) (Cód. 10780 F.1,20)	0,010
10738	Injetor 21mm - R. 1/8 BSP(E) x 1/8 BSP(E) (Cód. 179 F.0,60) (Cód. 416 F.0,80) (Cód. 417 F.0,90) (Cód. 419 F.1,10)	0,008



Qtd. mín. por código 10 un.

CÓD.	PRODUTO	PESO (Kg)
2596	Injetor 70mm - R. 1/8 BSP(E) (Cód. 10629 F.0,60) (Cód. 10791 F.0,80) (Cód. 10792 F.1,00) (Cód. 10793 F.1,20)	0,027
2593	Injetor 40mm - R. 1/8 BSP(E) (Cód. 10760 F.0,60) (Cód. 10782 F.0,80) (Cód. 600 F.0,90) (Cód. 10784 F.1,20)	0,016
3450	Injetor 34mm - R. 1/8 BSP(E) (Cód. 10617 F.0,60) (Cód. 140 F.0,80) (Cód. 10652 F.0,90) (Cód. 10651 F.1,10)	0,013
3451	Injetor 30mm - R. 1/8 BSP(E) (Cód. 10618 F.0,60) (Cód. 10794 F.0,80) (Cód. 10795 F.1,00) (Cód. 10796 F.1,20)	0,011
2579	Injetor 25mm - R. 1/8 BSP(E) (Cód. 10627 F.0,60) (Cód. 10659 F.0,80) (Cód. 405 F.1,00) (Cód. 670 F.1,20)	0,010
2586	Injetor 19mm - R. 1/8 BSP(E) (Cód. 10620 F.0,60) (Cód. 10801 F.0,85) (Cód. 7351 F.1,00) (Cód. 7350 F.1,20)	0,008



Qtd. mín. por código 10 un.

CÓD.	PRODUTO	PESO (Kg)
2570	Injetor 8mm R. 1/4 UNF (E)	0,001

(Cód 10606 F.0,60) (Cód 232 F.0,80)
(Cód 7008 F.0,85) (Cód 7012 F.0,90)



Qtd. mín. por código 10 un.

CÓD.	PRODUTO	PESO (Kg)
2572	Injetor 11mm R. 1/4 UNF (E)	0,002

(Cód 10607 F.0,60) (Cód 10705 F.0,75)
(Cód 251 F.0,85) (Cód 404 F.1,00)



Qtd. mín. por código 10 un.

CÓD.	PRODUTO	PESO (Kg)
2584	Injetor 11mm - R. 1/8 BSP(E) Brasil Antigo	0,005

(Cód 10664 F.0,60) (Cód 462 F.0,80)



Qtd. mín. por código 10 un.

CÓD.	PRODUTO	PESO (Kg)
2701	Injetor 8mm R. 5/16 UNF (E)	0,002

(Cód 8031 F.0,60) (Cód 7325 F.0,85)
(Cód 7124 F.0,90) (Cód 7407 F.1,20)



Qtd. mín. por código 10 un.

CÓD.	PRODUTO	PESO (Kg)
135	Injetor 11mm R. M6 tipo Brasil	0,002

(Cód 148 F.0,45) (Cód 136 F.0,60)
(Cód 756 F.0,85) (Cód 757 F.0,90)



CÓD.	PRODUTO	PESO (Kg)
2911	Porca- R. 1/4 BSP(I) p/ Tubo 1/4 e Registro Ramal	0,012



CÓD.	PRODUTO	PESO (Kg)
3242	Porca - R. M12 x 1 (I) p/ Tubo 1/4 e Registro Ramal	0,007



CÓD.	PRODUTO	PESO (Kg)
2813	Porca- R. 1/8 BSP(I) para Tubo 1/4	0,005



CÓD.	PRODUTO	PESO (Kg)
4636	Anilha para Tubo 3/8	0,001

7804	Anilha para Tubo 1/4	0,001
------	----------------------	-------

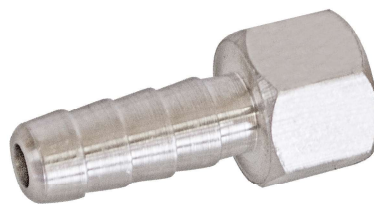
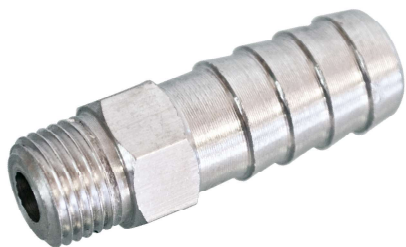

CÓD.	PRODUTO	PESO (Kg)
6503	Espiga - R. 1/8 NPT(E) x BM 3/8	0,006
6471	Espiga - R. 1/8 NPT(E) x BM 5/16	0,004
6475	Espiga - R. 1/8 NPT(E) x BM 1/4	0,004

CÓD.	PRODUTO	PESO (Kg)
6745	Espiga - R. 1/8 NPT(I) x BM 3/8	0,005
6482	Espiga - R. 1/8 NPT(I) x BM 5/16	0,005
6913	Espiga - R. 1/8 NPT(I) x BM 1/4	0,003

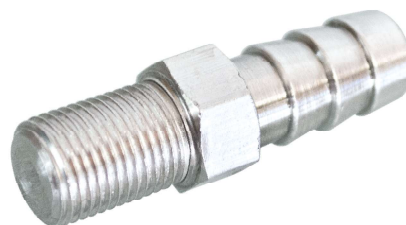

Qtd. mín. por código 10 un.

CÓD.	PRODUTO	PESO (Kg)
2968	Porca Ø46 x 11mm - R. 1/2 BSP(I) p/ Termômetro do Forno	0,011

CÓD.	PRODUTO	PESO (Kg)
6819	Injetor 39mm - R. 1/8 BSP(E) x BM 5/16	0,006

(Cód 7338 F.0,45) (Cód 10764 F.0,50) (Cód 10799 F.0,60)

8070	Injetor 39mm - R. 1/8 BSP(E) x BM 1/4	0,004
------	---------------------------------------	-------

(Cód 9900 F.0,30) (Cód 9897 F.0,45) (Cód 197 F. 0,60)



CÓD.	PRODUTO	PESO (Kg)
8115	Porca - R. 1/4 BSP(I) p/ Tubo 1/4	0,002
8272	Porca - M12 (I) p/ Tubo 1/4	0,002
7894	Porca - R. 1/8 BSP(I) p/ Tubo 1/4	0,001

CÓD.	PRODUTO	CÓD. BAR.	PESO (Kg)
1163	Caulin Zincado Branco 24mm Altura (Longo)		0,005
30113	Caulin Zincado Branco 24mm Altura (Longo) Emb. c/ 20 un.	7898586672642	0,132

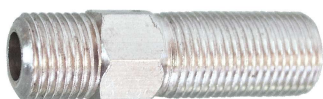

Qtd. mín. por código 10 un.

CÓD.	PRODUTO	PESO (Kg)
6500	Injetor 34mm - R. 1/8 BSP(E) x 1/8 BSP(E)	0,004

(Cód 8013 F.0,60) (Cód 8562 F.0,80)
(Cód 7243 F.0,90) (Cód 8563 F.1,20)

6504	Injetor 25mm - R. 1/8 BSP(E) x 1/8 BSP(E) Passante	0,001
------	--	-------



Qtd. mín. por código 10 un.

CÓD.	PRODUTO	PESO (Kg)
10676	Injetor 50 mm - R. 1/8 BSP(E) x 1/8 BSP(E) F. 0,60 c/ Arruela e Porca	0,026
10677	Injetor 60 mm - R. 1/8 BSP(E) x 1/8 BSP(E) F. 0,60 c/ Arruela e Porca	0,026
10678	Injetor 70 mm - R. 1/8 BSP(E) x 1/8 BSP(E) F. 0,60 c/ Arruela e Porca	0,026



Qtd. mín. por código 10 un.

CÓD.	PRODUTO	PESO (Kg)
6473	Injetor 11mm - R. 1/8 BSP(E)	0,001

(Cód 330 F.0,40) (Cód 150 F.0,60) (Cód 687 F. 0,70)



CÓD.	PRODUTO	PESO (Kg)
8410	Engate - R. 3/4 BSP(I) x BM 3/8	0,040



Qtd. mín. por código 10 un.

CÓD.	PRODUTO	PESO (Kg)
6506	Injetor 40mm - R. 1/8 BSP(E)	0,006

(Cód 256 F.0,60) (Cód 665 F. 0,85) (Cód 8622 F.1,10)

10215	Injetor 26mm - R. 1/8 BSP(E)	0,002
-------	------------------------------	-------

(Cód 7420 F.0,60) (Cód 10276 F.0,80)
(Cód 8060 F.1,10) (Cód 7405 F.1,20)

6480	Injetor 22mm - R. 1/8 BSP(E)	0,003
------	------------------------------	-------

(Cód 10622 F.0,60) (Cód 9915 F.0,85) (Cód 10610 F.1,00)



Qtd. mín. por código 10 un.

CÓD.	PRODUTO	PESO (Kg)
6505	Injetor 34mm - R. 1/8 NPT(E) x 1/8 BSP(E)	0,005

(Cód 10624 F.0,60) (Cód 8601 F.0,80)



CÓD.	PRODUTO	PESO (Kg)
6498	Injetor 20mm - R. 1/8 NPT(E)	0,003

(Cód 10608 F.0,60) (Cód 181 F.1,00)



CÓD.	PRODUTO	PESO (Kg)
8411	Tampão - R. 3/4 BSP(I)	0,029



CÓD.	PRODUTO	PESO (Kg)	CÓD.	PRODUTO	PESO (Kg)
3030	Engrenagem Alumínio Ø82 x 24mm Mod. 2,5 - c/ 30 Dentes - Furo Ø13mm p/ Espeto do Assador	0,085	3040	Engrenagem Alumínio Ø76 x 24mm Mod. 2,5 c/ 30 Dentes - Furo Ø13mm p/ Espeto do Assador	0,064



CÓD.	PRODUTO	PESO (Kg)	CÓD.	PRODUTO	PESO (Kg)	CÓD.	PRODUTO	PESO (Kg)
3041	Sem Fim Ferro Fundido Ø34,93 x 28mm. Mod. 2,5 p/ Varão 5/8" para Assador	0,090	6655	Sem Fim Alum. Ø34,93 x 41mm Mod. 2,5 p/ Varão 5/8" p/ todos os Modelos de Frangueiras	0,045	3043	Sem Fim Alum. Ø34,93 x 41mm Mod. 2,5 p/ Varão 5/8" para Assador	0,049



CÓD.	PRODUTO	PESO (Kg)	CÓD.	PRODUTO	PESO (Kg)	CÓD.	PRODUTO	PESO (Kg)
3026	Engrenagem Nylon Ø63 x 30mm Mod. 2 - c/ 29 Dentes Furo Ø16mm p/ Varão do Assador	0,055	3037	Sem Fim Ferro Fundido Ø34,93 x 35mm Mod. 2 p/ Eixo 1/2" Motor do Assador	0,126	10538	Engr. Nylon Grafitado Modelo Celeron Ø63 x 17mm Mod. 2 c/ 29 Dentes Furo Ø16mm c/ Parafuso	0,046



CÓD.	PRODUTO	PESO (Kg)
1930	Parafuso Allen sem Cabeça - R. 1/4 UNC x 1/4	0,001
8945	Parafuso Allen sem Cabeça - R. 1/4 UNC x 1/2	0,001



CÓD.	PRODUTO	PESO (Kg)
3047	Engrenagem Nylon Ø73 x 32mm Mod. 2,5 - c/ 26 Dentes Furo Ø16mm p/ Varão do Assador	0,067

CÓD.	PRODUTO	PESO (Kg)
6777	Engr. Nylon Ø73 x 30mm Mod. 2,5 - c/26 Dentes Furo Ø16mm c/ Anel p/ Conj. Redutor	0,105



CÓD.	PRODUTO	PESO (Kg)
686	Sem Fim Ferro Fundido Ø34,93 x 45mm Mod. 2,5 p/ Eixo 1/2" p/ Motor do Assador	0,156

CÓD.	PRODUTO	PESO (Kg)
6716	Sem Fim Ferro Fundido Ø34,93 x 35mm Mod. 2,5 p/ Varão 5/8"	0,102

CÓD.	PRODUTO	PESO (Kg)
2957	Engr. Nylon c/ 30% Fibra Ø73 x 32mm Mod. 2,5 - c/ 26 Dentes - Furo Ø16mm c/ Anel p/ Conj. Redutor	0,096



CÓD.	PRODUTO	PESO (Kg)
3261	Mancal Alumínio c/ Bucha de Lat. Ø16,05mm p/ Fixação do Eixo Assador	0,089

CÓD.	PRODUTO	PESO (Kg)
3456	Mancal Alumínio para Assador com Encaixe p/ Rolamento Ø35mm	0,074

CÓD.	PRODUTO	PESO (Kg)
3064	Engr. Nylon 30% Fibra Ø152 x 30mm Mod. 3 - c/ 48 Dentes Furo Ø25mm p/ Assador	0,260



CÓD.	PRODUTO	PESO (Kg)
7103	Espeto Duplo com Engrenagem Ø82mm e Varão 1/2 x 1110mm para Assador de Frango	1,568

CÓD.	PRODUTO	PESO (Kg)
8095	Espeto Duplo com Engrenagem Ø76mm e Varão 1/2 x 1110mm para Assador de Frango	1,562



CÓD.	PRODUTO	PESO (Kg)
3355	Espeto Completo com Engrenagem Ø82mm e Varão 1/2 x 1110mm	1,395
3402	Espeto Completo com Engrenagem Ø82mm e Varão 1/2 x 1230mm	1,542

CÓD.	PRODUTO	PESO (Kg)
3678	Varão Aço Zn Branco 1/2 x 1110mm com Cabo	1,085
3398	Varão Aço Zn Branco 1/2 x 1230mm com Cabo	1,225



CÓD.	PRODUTO	PESO (Kg)
8081	Varão 1/2 x 1110mm c/ Cabo e Engrenagem Ø82mm	1,174
8082	Varão 1/2 x 1230mm c/ Cabo e Engrenagem Ø82mm	1,320

CÓD.	PRODUTO	*Esmaltado	PESO (Kg)
1018	Espeto Espada com Engrenagem Ø82mm e Varão 1/2 x 1110mm para Assador de Frango		1,351



*Embalagem com 50 unidades

*Embalagem com 50 unidades

*Embalagem com 50 unidades

CÓD.	PRODUTO	PESO (Kg)
3323	Garfo de Aço Duplo c/ Bucha de Alum. p/ Assador c/ Varão 1/2 (c/ Parafuso)	0,040

CÓD.	PRODUTO	PESO (Kg)
3322	Garfo de Aço Simples c/ Bucha de Alum. p/ Assador c/ Varão 1/2 (c/ Parafuso)	0,030

CÓD.	PRODUTO	PESO (Kg)
7038	Garfo Aço Duplo c/ Bucha de Alum. p/ Assador c/ Varão 1/2 (c/ Parafuso).	0,064



*Embalagem com 50 unidades

CÓD.	PRODUTO	PESO (Kg)
7039	Garfo de Aço Simples c/ Bucha de Alum. p/ Assador c/ Varão 1/2 (c/ Parafuso)	0,054

CÓD.	PRODUTO	PESO (Kg)
3078	Bucha de Aço Zb p/ Varão do Assador Ø25,4 x Ø16,1 x 16mm - R. 1/4 UNC.	0,036

CÓD.	PRODUTO	PESO (Kg)
1927	Parafuso Sext. R. 1/4 UNC x 1/2 Zn Branco	0,005



40 a 50mm

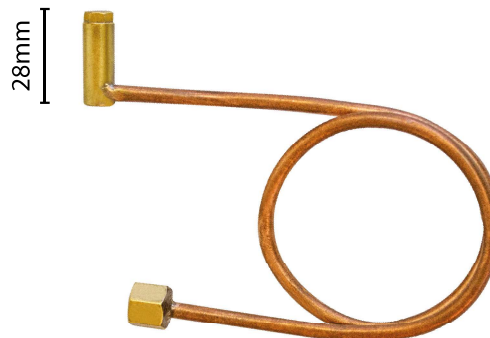

28mm

CÓD.	PRODUTO	PESO (Kg)
6957	Maçaneta Cromada Espessura da Porta de 40 a 50mm	1,042

CÓD.	PRODUTO	PESO (Kg)
2741	Ligação de Cobre 3/16 x 450mm R. 1/8 NPT(I) Injetor Furo 0,85mm	0,059

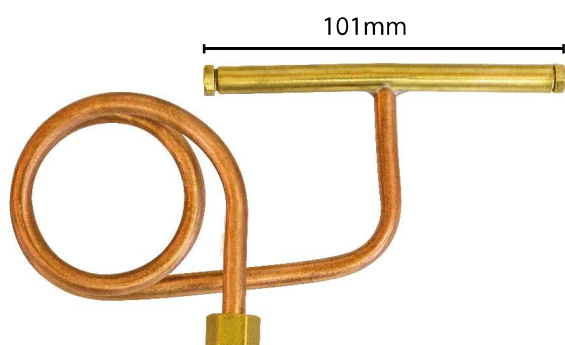

101mm

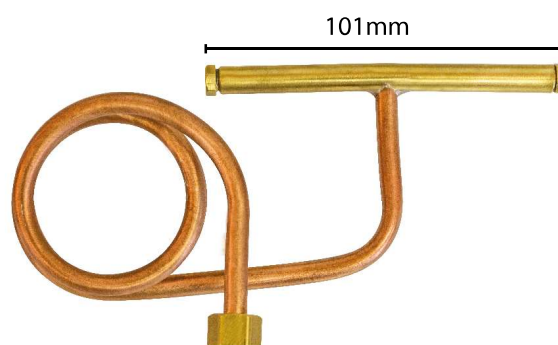

101mm

CÓD.	PRODUTO	PESO (Kg)
2617	Ligação de Cobre 1/4 x 550mm c/ Tubo Injetor Furo 1,00mm Porca 1/4 Grossa	0,108

CÓD.	PRODUTO	PESO (Kg)
2756	Ligação Cobre 1/4 x 440mm c/ Tubo Injetor Furo 0,95mm x 1/8 BSP(I)	0,089

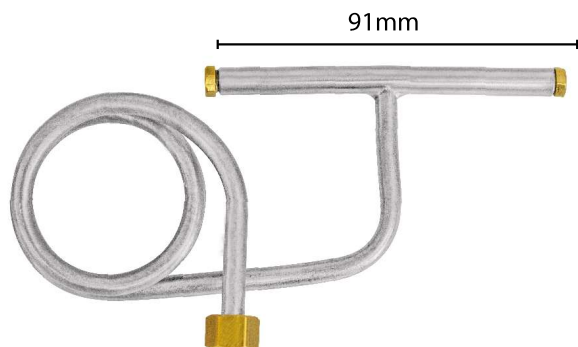

91mm

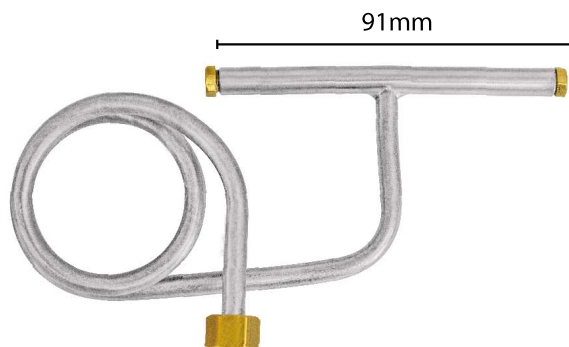

91mm

CÓD.	PRODUTO	PESO (Kg)
7489	Ligação Alumínio 1/4 x 410mm c/ Tubo Injetor Furo 0,90mm x 1/8 BSP (I)	0,037

CÓD.	PRODUTO	PESO (Kg)
7494	Ligação Alum. 1/4 x 698mm c/ Tubo Injetor Furo 0,90mm x 1/8 BSP(I)	0,043



*Embalagem Coletiva

CÓD.	PRODUTO	CÓD. BAR.	PESO (Kg)
1117	Flex Mang PT300 9/16(E) x 3/8(I) x 1000mm Ponta x Ponta	7908212309269	0,217
1118	Flex Mang PT300 9/16(E) x 3/8(I) x 1200mm Ponta x Ponta	7908212309276	0,260
1120	Flex Mang PT300 9/16(E) x 3/8(I) x 1500mm Ponta x Ponta	7908212309283	0,326
1121	Flex Mang PT300 9/16(E) x 3/8(I) x 2000mm Ponta x Ponta	7908212309290	0,434
1322	Flex Mang PT300 9/16(E) x 3/8(I) x 3000mm Ponta x Ponta	7908212309863	0,651
1323	Flex Mang PT300 9/16(E) x 3/8(I) x 5000mm Ponta x Ponta	7908212309870	1,085

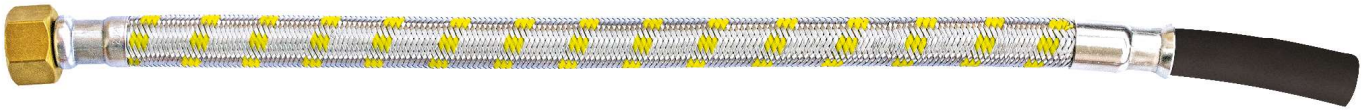

*Embalagem Coletiva

CÓD.	PRODUTO	CÓD. BAR.	PESO (Kg)
1151	Flexível Mangueira PT300 9/16(E) x 3/8(I) x 800mm - R.1/2 BSP(I) x Ponta	7908212309733	0,195
1113	Flexível Mangueira PT300 9/16(E) x 3/8(I) x 1000mm - R.1/2 BSP(I) x Ponta	7908212309221	0,243
1114	Flexível Mangueira PT300 9/16(E) x 3/8(I) x 1200mm - R.1/2 BSP(I) x Ponta	7908212309238	0,292
1115	Flexível Mangueira PT300 9/16(E) x 3/8(I) x 1500mm - R.1/2 BSP(I) x Ponta	7908212309245	0,365
1116	Flexível Mangueira PT300 9/16(E) x 3/8(I) x 2000mm - R.1/2 BSP(I) x Ponta	7908212309252	0,486

Flexível Mangueira PT300 com Trama de Aço Inox 304

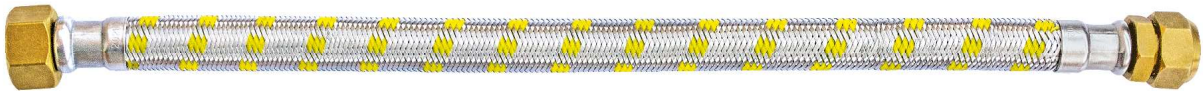

*Embalagem Coletiva

CÓD.	PRODUTO	CÓD. BAR.	PESO (Kg)
1099	Flexível Mangueira PT300 9/16(E) x 3/8(I) x 1000mm - R.1/2 BSP(I) x Aperto Rap.	7908212309184	0,281
1101	Flexível Mangueira PT300 9/16(E) x 3/8(I) x 1200mm - R.1/2 BSP(I) x Aperto Rap.	7908212309726	0,337
1110	Flexível Mangueira PT300 9/16(E) x 3/8(I) x 1500mm - R.1/2 BSP(I) x Aperto Rap.	7908212309207	0,422
1112	Flexível Mangueira PT300 9/16(E) x 3/8(I) x 2000mm - R.1/2 BSP(I) x Aperto Rap.	7908212309214	0,562
1223	Flexível Mangueira PT300 9/16(E) x 3/8(I) x 3000mm - R.1/2 BSP(I) x Aperto Rap.	7908212309535	0,843
1225	Flexível Mangueira PT300 9/16(E) x 3/8(I) x 4000mm - R.1/2 BSP(I) x Aperto Rap.	7908212309542	1,124
1226	Flexível Mangueira PT300 9/16(E) x 3/8(I) x 5000mm - R.1/2 BSP(I) x Aperto Rap.	7908212309559	1,405

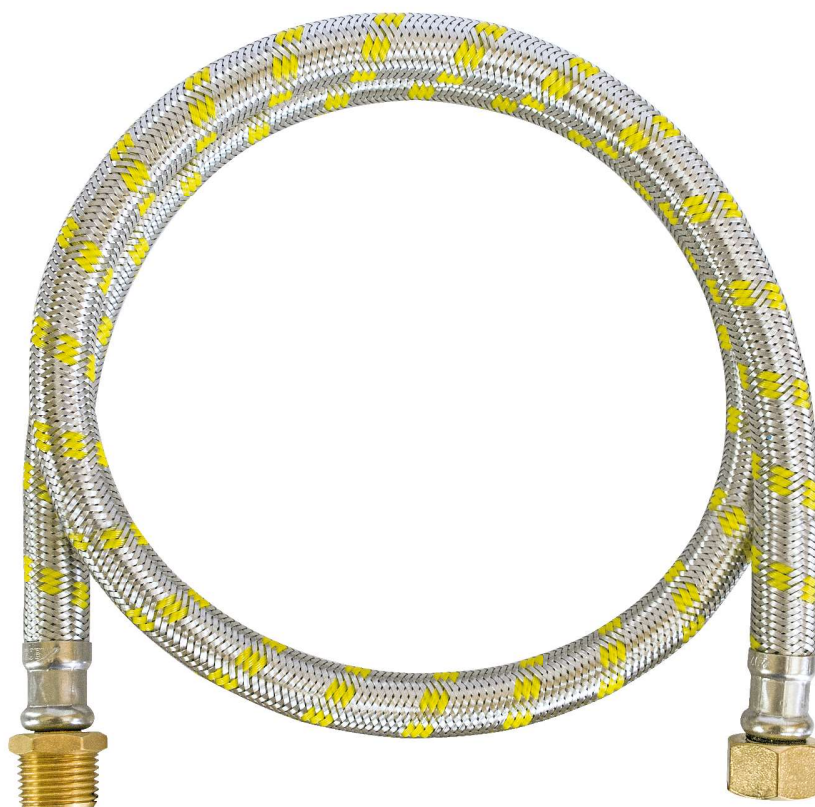

*Embalagem Coletiva

CÓD.	PRODUTO	CÓD. BAR.	PESO (Kg)
1149	Flexível Mangueira PT300 9/16(E) x 3/8(I) x 400mm - R.1/2 NPT(E) x 1/2 BSP(I)	7908212309740	0,106
1302	Flexível Mangueira PT300 9/16(E) x 3/8(I) x 800mm - R.1/2 NPT(E) x 1/2 BSP(I)	7908212309887	0,210
1152	Flexível Mangueira PT300 9/16(E) x 3/8(I) x 1000mm - R.1/2 NPT(E) x 1/2 BSP(I)	7908212309757	0,263
1153	Flexível Mangueira PT300 9/16(E) x 3/8(I) x 1200mm - R.1/2 NPT(E) x 1/2 BSP(I)	7908212309764	0,316
1154	Flexível Mangueira PT300 9/16(E) x 3/8(I) x 1500mm - R.1/2 NPT(E) x 1/2 BSP(I)	7908212309771	0,395
1155	Flexível Mangueira PT300 9/16(E) x 3/8(I) x 2000mm - R.1/2 NPT(E) x 1/2 BSP(I)	7908212309788	0,526
1324	Flexível Mangueira PT300 9/16(E) x 3/8(I) x 3000mm - R.1/2 NPT(E) x 1/2 BSP(I)	7908212309894	0,789
1325	Flexível Mangueira PT300 9/16(E) x 3/8(I) x 4000mm - R.1/2 NPT(E) x 1/2 BSP(I)	7908212309900	1,052
1327	Flexível Mangueira PT300 9/16(E) x 3/8(I) x 5000mm - R.1/2 NPT(E) x 1/2 BSP(I)	7908212309917	1,315



NPT: Rosca cônica 55°

BSP: Rosca paralela

BSPT: Rosca cônica 60°

P2RF: Rosca para botijão P2 rosca fina

P13R6: Rosca para botijão P13 rosca grossa

AP: Alta pressão

(E): Externo

(I): Interno

BM: Espiga tipo “bico de mamadeira”

PN: Pressão nominal

DN: Diâmetro nominal

UNF-NF: Rosca fina - polegada

UNC-NC: Rosca grossa - polegada

UNEF-NS: Rosca extra-fina - polegada

SAE: Diâmetro do tubo

Consulte nossos canais de atendimento



AMAZONAS



AMAPÁ



MATO GROSSO
DO SUL



PARANÁ



RONDÔNIA



RORAIMA



SANTA
CATARINA



TOCANTINS

atendimento@maqenge.com.br

 54 99611-3769



BAHIA



CEARÁ



MARANHÃO



MINAS
GERAIS



PERNAMBUCO



PIAUI



RIO DE
JANEIRO



RIO GRANDE
DO NORTE

comercial1@maqenge.com.br

 54 99617-1238



ALAGOAS



ESPIRITO
SANTO



PARAÍBA



RIO GRANDE
DO SUL



SERGIPE

comercial@maqenge.com.br

 54 99667-3768



ACRE



DISTRITO
FEDERAL



GOIÁS



MATO GROSSO



PARÁ



SÃO PAULO

vendas@maqenge.com.br

 54 9953-3770



EXPORTAÇÃO



importacaoex@maqenge.com.br

export@maqenge.com.br

 54 99698-5685



Maqenge®

Acesse nosso
catálogo digital



MAQENGE - INDÚSTRIA METALÚRGICA LTDA
Rua Augusto Ártico, 26 - CEP 95074-410
Nossa Senhora de Lourdes - CAXIAS DO SUL - RS
FONE: 54 3535-3050

www.maqenge.com.br